

mRAID16 Storage System Product Description

active™
S T O R A G E

About This Document

This document describes the orientation, features, architecture, technical specifications, product configuration, environment requirements, standard compliance and granted certifications of the mRAID16 storage system.

Intended Audience

This document is intended for: All readers

Conventions

The purchased products, services, and features are stipulated by the commercial contract made between Active Storage and the customer. All or partial products, services and features described in this document may not be within the purchased scope or the usage scope. Unless otherwise agreed by the contract, all statements, information, and recommendations in this document are provided "AS IS" without warranties, guarantees, or representations of any kind, either express or implied.

As part of an effort to improve and enhance the product performance and capabilities, Active Storage, LLC periodically releases revisions of the hardware and software. Therefore, some functions described in this document may not be supported by all versions of the software or hardware currently in use. For the most up-to-date information about product features, refer to the product release notes.

If a product does not function as described in this document, contact Active Storage technical support engineers.

Contents

About This Document

1 Product Positioning	1
2 Product Features	3
3 Typical Applications	7
3.1 High-Performance Applications	7
3.2 High-Availability Applications	8
3.3 High-Density and Multi-Service Applications	10
4 Hardware Architecture	12
4.1 Device Composition	12
4.2 2 U Controller Enclosure	13
4.2.1 Overview.....	13
4.2.2 Component Description	16
4.2.3 Indicator Introduction	37
4.3 4 U Disk Enclosure (3.5-Inch Disks).....	41
4.3.1 Overview.....	41
4.3.2 Component Description	43
4.3.3 Indicator Introduction	51
4.4 High-Density Disk Enclosure	53
4.4.1 Overview.....	54
4.4.2 Component Description	56
4.4.3 Indicator Introduction	61
4.5 Device Cables	64
4.5.1 Power Cables	65
4.5.2 Ground Cables	65
4.5.3 Network Cables	66
4.5.4 Serial Cables	66
4.5.5 Mini SAS HD Cables	67
4.5.6 Optical Fibers.....	68
4.5.7 FDR Cables.....	69
4.5.8 MPO-4*DLC Fiber.....	69
5 Product Specifications	71

5.1 Hardware Specifications	71
5.2 Software Specifications.....	76
6 Environmental Requirements.....	79
6.1 Temperature, Humidity, and Altitude	79
6.2 Particle Contaminants	80
6.3 Corrosive Airborne Contaminants	81
6.4 Heat Dissipation and Noise.....	84
7 Standard Compliance	86
8 Certifications.....	90
9 Operation and Maintenance	93
A How to Obtain Help	95
A.1 Preparations For Contacting Active Storage.....	95
A.1.1 Collecting Troubleshooting Information.....	95
A.1.2 Making Debugging Preparations.....	96
A.2 How to Use the Document	96
A.3 How to Obtain Help from Website	96
A.4 Ways to Contact Active Storage	96
B Glossary.....	97
C Acronyms and Abbreviations	109

1 Product Positioning

The mRAID16 is a mid-range and high-end storage product newly developed by Active Storage. This series is ideal for processing existing storage applications and follows the future development trend of storage technologies. It meets medium- and large-sized enterprises' storage requirements for mass data storage, speed data access, high availability, high utilization, energy saving, and ease-of-use.

Business development leads to a great amount of service data, which poses ever high demands on storage systems. Traditional storage systems fail to meet these demands and encounter the following bottlenecks: inflexible storage performance expansion, complex management of various devices, failure to utilize legacy devices, and increasing maintenance costs occupying a large part of Total Cost of Ownership (TCO). To eliminate these bottlenecks, Active Storage has launched the mRAID16 storage system.

The mRAID16 storage system offers comprehensive and superb solutions by providing industry-leading performance, diverse efficiency boost mechanisms, as well as file-level and block-level data storage and various storage protocols on a single platform. Those solutions help customers maximize their return on investment (ROI) and meet the requirements of different application scenarios such as Online Transaction Processing (OLTP) and Online Analytical Processing (OLAP) of large databases, high-performance computing (HPC), digital media, Internet operation, centralized storage, backup, disaster recovery, and data migration.

In addition to providing high-performance storage services for application servers, mRAID16 storage system supports advanced data backup and disaster recovery technologies, ensuring the secure and smooth running of data services. Also, mRAID16 storage system offers easy-to-use management modes and convenient local/remote maintenance modes, greatly decreasing the management and maintenance costs.

Position and Application of the Storage System on an Integrated NAS and SAN Network

Figure 1-1 shows the position and application of the storage system on an integrated NAS and SAN network.

Figure 1-1 Position and application of the storage system on an integrated NAS and SAN network

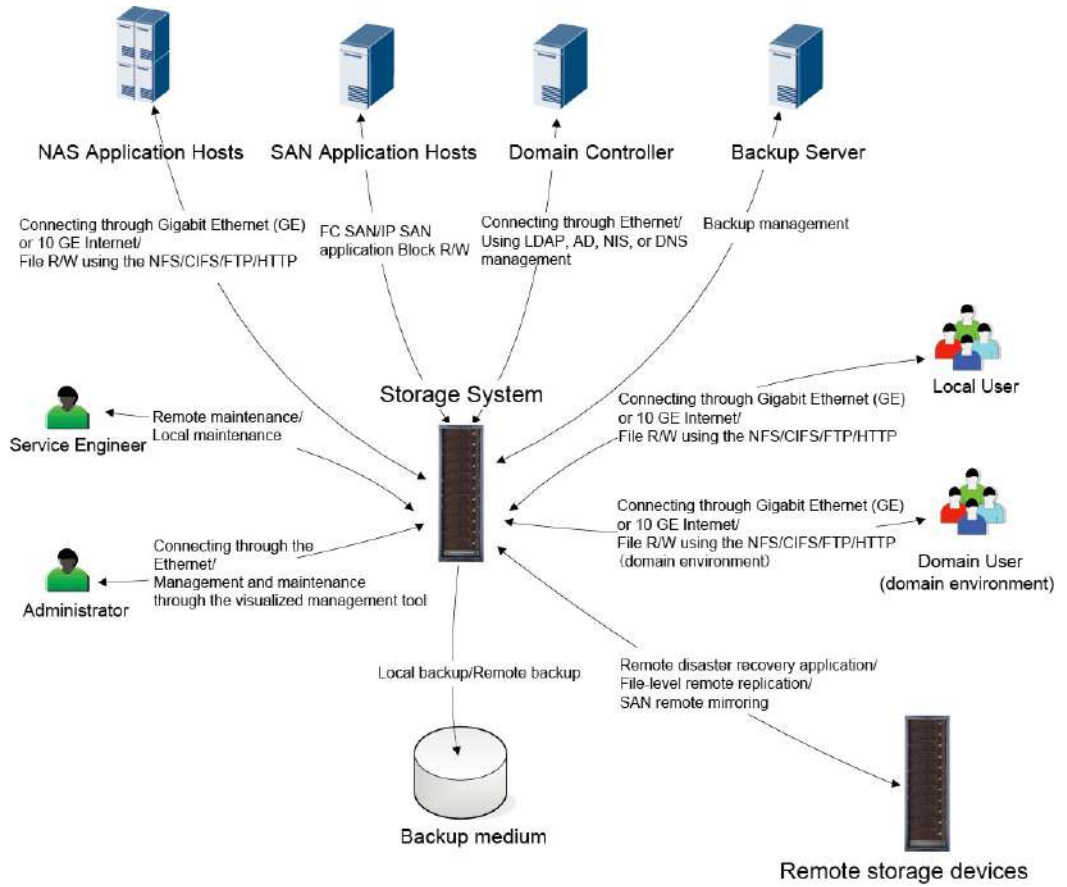

2 Product Features

Powered by a superior hardware structure, an integrated block and file software architecture, as well as advanced data applications and protection technologies, the mRAID16 storage system provides high performance, superb scalability, robust reliability, and high availability, meeting medium- and large-sized enterprises' different storage requirements.

High Performance

The mRAID16 storage system offers a three-level performance acceleration technology, and delivers hierarchical performance for different applications. The three levels are:

1. Superior hardware

The mRAID16 storage system is equipped with 64-bit multi-core processors, high-speed and large-capacity caches, and various high-speed interface modules. The superior hardware allows the mRAID16 storage system to offer better storage performance than tradition storage systems.

2. Solid state drives (SSDs)

The mRAID16 storage system can be fully configured with SSDs to provide peak performance for the most-demanding applications.

In addition, users can insert external acceleration modules into the storage system for higher system performance. For example, inserting Smart ACC modules improves system deduplication and compression performance while reducing CPU usage.

Flexible Scalability

The mRAID16 storage system has an outstanding scalability. It supports various types of disks and host interface modules. Also, the interface modules have a high density. The supported multiple types and high-density interface modules bring a high system scalability.

The mRAID16 storage system supports the following types of disks and interface modules:

- 1 Types of disks:

SAS disks, NL-SAS disks, and SSDs.

- 1 Types of host interface modules:

8 Gbit/s fiber channel, 16 Gbit/s fiber channel, GE, 10 Gbit/s TOE, 10 GE, 10 Gbit/s FCoE, 56 Gbit/s(4*14 Gbit/s) IB and SmartIO.

The mRAID16 storage system also supports Scale-out expansion of clustered nodes for system performance improvement.

Proven Reliability

The mRAID16 storage system offers protection measures against component failures and power failure, and uses advanced technologies to minimize risks of disk failures and data loss. This ensures the proven reliability of the storage system.

1 Against component failures

The storage system components are in 1+1 redundancy and work in active-active mode. Normally, every two components are working simultaneously and share loads. If one component fails or gets offline, the other one takes over all loads and speeds up to compensate. The whole process is transparent to applications.

1 RAID 2.0+ underlying virtualization

The storage system employs innovative RAID 2.0+ underlying virtualization technology for automatic disk load balancing. If a disk encounters a fault, all the other disks in the same disk domain help construct the faulty disk's service data, achieving a 20-fold faster reconstruction speed than traditional RAID technology. In addition, RAID 2.0+ significantly reduces the possibility of multi-disk failure.

1 Against unexpected downtime

The storage system is equipped with backup battery modules (BBUs) that provide power for the controller enclosure in the event of a power failure. This protects the data in the cache and dumps it to the build-in disks of the controllers to avoid data loss.

1 Bad sector repair

The storage system is prone to bad sectors of disks. The mRAID16 storage system adopts the bad sector repair technology to proactively detect and repair bad sectors, reduce the disk failure rate by 50%, and prolong the service life of disks.

1 Disk pre-copy

The disk pre-copy technology enables the storage system to routinely check the hardware status and migrate data from any failing disk to minimize the risks of data loss.

High System Security

Storage Network Security

1 Security of management channels

The management operations from physical ports are controlled by the access authentication mechanism of the storage system, and only authorized users are allowed to manage the storage system.

1 Anti-attack protection for protocols and ports

The storage system provides only necessary ports to the external for system operations and maintenance. All the ports used are listed in the *Communication Matrix*. Dynamic listening ports are functioning in the proper scope, and no unopened port exists.

1 Service ports are isolated from management ports

The Access Control List (ACL) mechanism is adopted to isolate Ethernet ports from internal heartbeat network ports, management network ports, and maintenance network ports.



NOTE

Internal heartbeat links are established between controllers for these controllers to detect each other's working status. You do not need to separately connect cables.

Storage Service Security

1 Security of the operating system

The storage system uses a dedicated operating system. Security of the operating system has been hardened before the storage system is delivered. The storage systems update security patches for their operating systems and open-source software based on site requirements, safeguarding users' data.

1 Encrypted data transfer

Virtual private network (VPN) devices are used to establish an internet small computer system interface (iSCSI) transfer channel between two storage devices and data transferred between storage devices is encrypted to ensure privacy and security. Therefore, encrypted data transfer can apply to service data transfer in using value-added features, such as LUN copy, synchronous remote replication, and asynchronous remote replication.

1 Data storage encryption

- The storage system supports data encryption by using a network password manager. The network password manager employs the standard cryptographic algorithm supported by the State Encryption Administration of China. It allows only the hosts that comply with security policies to access storage system data by auditing access control policies and controlling access attempts from hosts. After the network password manager is deployed, all mutual information between the hosts and storage system will pass the network password manager to enable read/write data encryption and decryption and ensure data security of the storage system.
- The storage system supports disk encryption. The hardware circuits and internal data encrypt key of disks are used for data writing encryption and data reading decryption. To ensure the security of data encrypt key, the storage system and the third-party key management server jointly provide a highly secure, reliable, and available key management solution.

1 Data sanitation

When deleting unwanted data, the system erases the specified LUN to make the deleted data unable to be restored, preventing critical data leaks.

Storage Management Security

1 Security of management and maintenance

The operations of users can be allowed and denied. All management operations are logged by the system.

Virtualization, Intelligence, and Efficiency

The mRAID16 storage system absorbs the concept of "Virtualization, Intelligence, and Efficiency", which fits the up-to-date storage design idea and wins a leading position for the storage system. Compared with traditional storage systems, the mRAID16 storage system achieves a higher storage space usage, faster data reconstruction speed, smarter performance allocation technology, and finer service quality control. To obtain the previous achievements, the following technologies contribute:

1 RAID 2.0+ underlying virtualization

RAID 2.0+ underlying virtualization technology divides disk storage space into small-sized data blocks and uses the blocks to create RAID groups for fine-grained resource management. The technology realizes automatic load balancing, higher storage performance, better storage space utilization, faster disk reconstruction, and delicate storage space management. RAID 2.0+ serves as a basis for a number of other advanced storage technologies. Economy and Ease-of-Use

The mRAID16 storage system employs intelligent CPU frequency control, delicate fan speed control, deduplication and compression to improve economy. It also provides a series of management and maintenance tools to simplify operation and maintenance tasks.

1 Economy

- Intelligent CPU frequency control
Automatically changes the CPU frequency based on the system loads, that is, it decreases the CPU frequency and power consumption during off-peak hours for a low operation cost and long CPU service life.
- Delicate fan speed control
Dynamically adjusts the fan speed based on the storage system's temperature. It lowers the noise and power consumption and cuts the operation cost.
- Deduplication and compression
Checks and processes duplicate data in disks based on deduplication, and minimizes space occupied by data based on compression to improve disk utilization.

1 Ease-of-use

- ActiveManager
The ActiveManager is a storage system management tool based on a graphical user interface (GUI) and enables you to efficiently manage storage systems by wizard-based operations.
- Integrated management
Implements convenient device management by integrating a management plug-in into mainstream management software such as VMware vCenter plug-in, Hyper-V System Center, vSphere API for Storage Awareness (VASA), vSphere Storage APIs for Array Integration (VAAI), and Volume Shadow Copy Service (VSS) Provider.
- Pad management
Supports flexible storage system management on a pad.
- Various alarm notification methods
Provides alarm notification by sound, indicator, short message service (SMS), and email.
- One-click upgrade tool
Provides one-click upgrade for controllers. It simplifies the upgrade operation and makes the procedure transparent to users.

3 Typical Applications

About This Chapter

The mRAID16 storage system offers industry-leading hardware specifications, a flexible and reliable hardware design, a virtualized underlying architecture, and a variety of data protection technologies, addressing the needs of differentiated storage applications. The typical applications of the mRAID16 storage system include but are not limited to high-performance, high-availability, or high-density and multi-service applications.

3.1 High-Performance Applications

The mRAID16 storage system incorporates various technologies to boost the system performance. Its high-performance hardware delivers outstanding data access performance. The virtualization technology can improve the storage performance continuously and it shatters performance bottlenecks caused by data explosion.

3.2 High-Availability Applications

The mRAID16 storage system has a highly reliable design, achieving a long mean time between failures (MTBF), and ensuring high availability of storage applications. It also incorporates a variety of data protection technologies, and protects data integrity and service continuity against catastrophic disasters.

3.3 High-Density and Multi-Service Applications

The mRAID16 storage system delivers industry-leading density of interface modules in an enclosure and a flexible configuration of interface modules and hard disks of different types. This design makes the mRAID16 storage system suitable for high-density and multi-service applications.

3.1 High-Performance Applications

The mRAID16 storage system incorporates various technologies to boost the system performance. Its high-performance hardware delivers outstanding data access performance. The virtualization technology can improve the storage performance continuously and it shatters performance bottlenecks caused by data explosion.

On-Demand System Performance Boost

The performance of a storage system was provisioned to meet the initial application requirements. However, the future growth of applications is always beyond expectation, and the performance of a traditional storage system is gradually consumed up and finally restricts the system functionality. The virtualization technology of the mRAID16 storage system can address this issue. It dynamically increases storage performance based on the application requirement. This prolongs the system service life and lowers customers' total cost of ownership (TCO).

After the initial purchase, the storage system is equipped with affordable hard disk drives (HDDs) to deliver data storage services. As the service requirements increase and the storage system performance becomes insufficient, administrators can add HDDs of high speeds or solid state drives (SSDs) to boost the system performance. When the service requirements reach a new peak and are starved of storage system performance, administrators can replace all the existing HDDs with SSDs to further adapt the system performance to the new requirements.

This on-demand system performance boost brings the following benefits:

- 1 The system performance is improved gradually, balancing the return on investment (ROI) and the system service life.
- 1 Components for upgrade are available, following the Moore's Law to reduce the purchase cost and the TCO.

3.2 High-Availability Applications

The mRAID16 storage system has a highly reliable design, achieving a long mean time between failures (MTBF), and ensuring high availability of storage applications. It also incorporates a variety of data protection technologies, and protects data integrity and service continuity against catastrophic disasters.

In-Service Routine Maintenance

In traditional storage systems, routine maintenance tasks, such as component replacement and capacity expansion, must be implemented in offline mode. The mRAID16 storage system, however, assembles advanced technologies for in-service routine maintenance:

- 1 TurboModule
 - Enables online replacement of components and requires no system restart.
- 1 Online capacity expansion
 - Allows online addition of disks and expansion of storage pools.

Tolerance of Single Points of Failures

The mRAID16 storage system incorporates a hierarchical redundancy design to eliminate the impacts of single points of failures:

- 1 Hardware redundancy
 - All components of the mRAID16 storage system are in redundancy and work in active-active mode. If one component fails, the other speeds up to compensate so that the storage system can continue operating.
- 1 Link redundancy

If there is only one link between the storage system and an application server, the disconnection of the link terminates the communication in between. To eliminate this failure, the mRAID16 storage system uses two or more links to communicate with the application server. Therefore, if one link is down, the other links take over the services to continue the data transmission.

1 Application server clustering

If the storage system cooperates with only one application server, the failure of the application server interrupts services. Application server clustering can address this issue. A cluster consists of two or more application servers that share loads. If one application server in the cluster fails, the other application servers take over its loads, and the whole process is transparent to users. Application server clustering supported by the mRAID16 storage system ensures business continuity.

Based on the previous protection mechanisms, the mRAID16 storage system has proven tolerance of single points of failure, as shown in Figure 3-1.

Figure 3-1 Tolerance of single points of failure

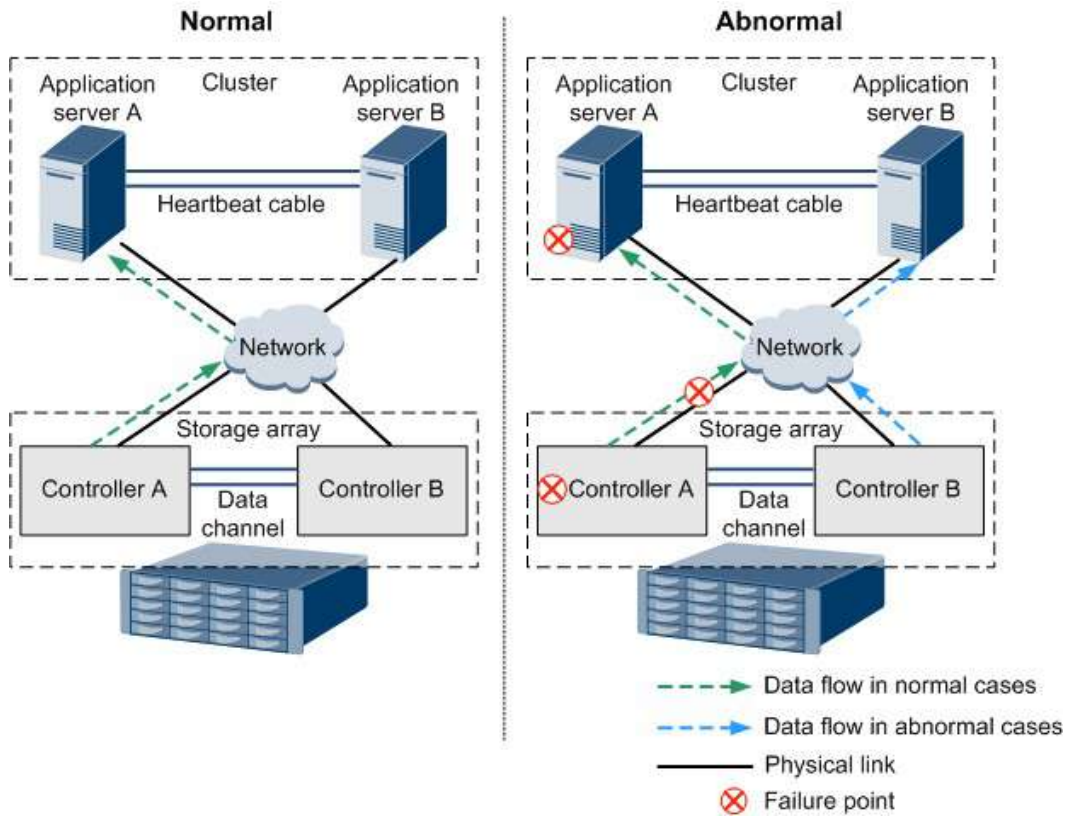

In the example in Figure 3-1, application server A and controller A are faulty, so a link between the cluster and the storage system is down. Under this circumstance, the redundant components and links compensate for the failed ones. This ensures the nonstop system operations and greatly improves the service availability.

Resilience Against Disasters

The mRAID16 storage system compliments various data protection methods for backup and disaster recovery. Those methods eliminate the risks of unexpected downtime and data loss caused by natural disasters, serious device failures, or man-made misoperations.

The supported data protection methods include:

3.3 High-Density and Multi-Service Applications

The mRAID16 storage system delivers industry-leading density of interface modules in an enclosure and a flexible configuration of interface modules and hard disks of different types. This design makes the mRAID16 storage system suitable for high-density and multi-service applications.

High-Density Virtual Machine Applications

The virtual machine technology greatly improves application servers' utilization, and lowers services' deployment and operating expense. Therefore, it is popular in many application scenarios. However, virtual machines are now facing a challenge, that is, they are equipped with an increasing number of application systems and virtual desktops, leading to the high density of virtual machines. Compared with a single server, high-density virtual machines generate more service data, consume more bandwidth, and pose more demanding requirements on performance and scalability.

Excellent in both performance and compatibility, the mRAID16 storage system is ideal for high-density virtual machine applications:

- 1 The three-level performance acceleration technology provides robust storage performance for high-density virtual machine applications.
- 1 The proprietary TurboModule technology significantly improves the density of interface modules in a single enclosure. This high-density design translates into a capability to support hundreds of virtual machines.
- 1 Various virtual machine applications are supported, including VMware, Hyper-V, and Citrix Xen.

Multi-Service Applications

It is a tendency nowadays for one storage system to process diversified applications. However, those applications have differentiated requirements on storage, therefore, the storage system must have high flexibility in performance and networking.

Each type of services has its specific requirements for storage system:

- 1 Database servers (featuring unstructured data): high requirements on storage performance, data integrity, and system stability.
- 1 Mail servers (featuring high randomness of concurrent accesses): high requirements on storage performance, data integrity, and system stability.
- 1 Video servers: high requirements on storage capacity, data access continuity, and continuous bandwidths.
- 1 Backup servers: low requirements on performance and bandwidths.

The mRAID16 storage system supports an intermixed configuration of solid state drives (SSDs), SAS disks, and NL-SAS disks to deliver an optimal performance.

¹ SSDs: deliver the highest performance among these three types of disk, and are suitable for application servers such as busy database servers and mail servers that require superior storage performance.

¹ SAS disks: deliver performance lower than SSDs but higher than NL-SAS disks, and are suitable for application servers such as common database servers, mail servers, and high-definition (HD) video servers that have a moderate storage performance requirement.

¹ NL-SAS disks: deliver the lowest performance among these three types of disk, and are suitable for application servers such as low-end video servers and backup servers that have a low storage performance requirement.

The mRAID16 storage system has a flexible configuration of front-end interface modules with customizable transmission rates, respectively addressing the storage requirements in fiber Channel networks and Ethernet networks, or of fiber Channel data transmission in Ethernet networks.

4 Hardware Architecture

About This Chapter

The mRAID16 storage system hardware is the basis of data storage. A storage unit typically consists of a controller enclosure or a controller enclosure plus disk enclosures.

4.1 Device Composition

A storage system consists of a controller enclosure and one or more disk enclosures, and it provides an intelligent storage platform that features robust reliability, high performance, and large capacity.

4.2 2 U Controller Enclosure

This chapter describes a controller enclosure in terms of its hardware structure, component functions, front and rear views, and indicators.

4.3 4 U Disk Enclosure (3.5-Inch Disks)

This chapter describes a disk enclosure in terms of its hardware structure, component functions, front and rear views, and indicators.

4.4 High-Density Disk Enclosure

This chapter describes a high-density disk enclosure in terms of its hardware structure, component functions, front and rear views, and indicators.

4.5 Device Cables



Device cables used in the storage system include power cables, ground cables, and signal cables. This chapter displays the views and describes the functions and specifications of various cables.

4.1 Device Composition

A storage system consists of a controller enclosure and one or more disk enclosures, and it provides an intelligent storage platform that features robust reliability, high performance, and large capacity.

Different product models are configured with different types of controller enclosures and disk enclosures. Table 4-1 lists the controller enclosures and disk enclosures used by different product models.

Table 4-1 Controller enclosures and disk enclosures used by different product models

Product Model	Controller Enclosure	Disk Enclosure
mRAID16	12 U disk enclosure with 12 disk slots 	14 U disk enclosure with 24 disk slots  14 U High-density disk enclosure 

4.2 2 U Controller Enclosure

This chapter describes a controller enclosure in terms of its hardware structure, component functions, front and rear views, and indicators.

4.2.1 Overview

The controller enclosure adopts a modular design and consists of a system enclosure, controllers, power-BBU modules, and disk modules.

Overall Structure

0 shows the overall structure of a 2 U 12-disk controller enclosure.

Overall structure of a 2 U 12-disk controller enclosure

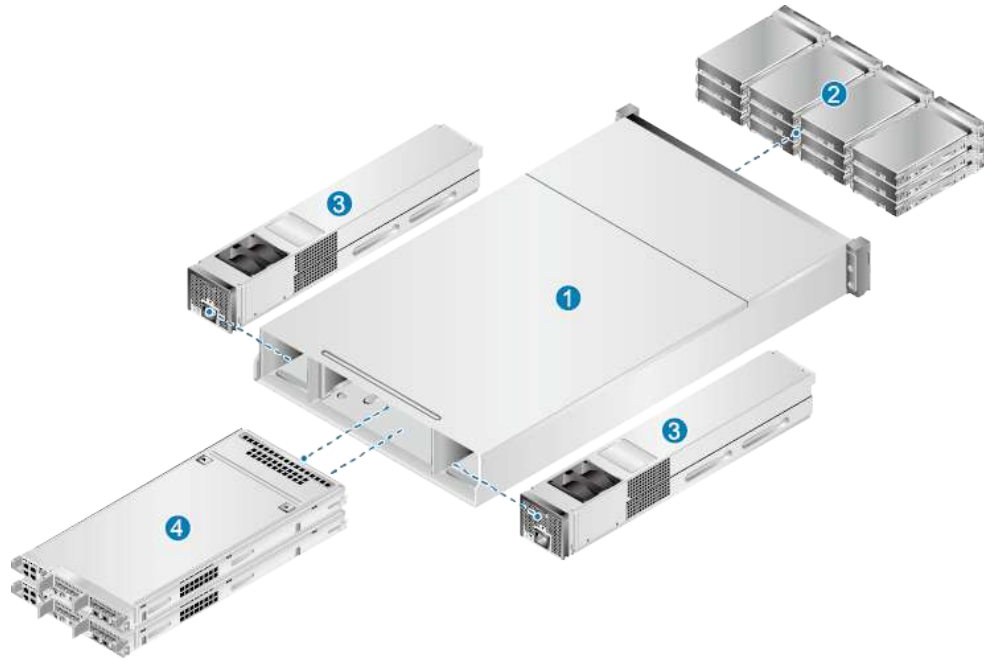

- | | | | |
|---|------------------|---|-------------|
| 1 | System enclosure | 2 | Disk module |
| 3 | Power-BBU module | 4 | Controller |



NOTE

In the rear view of a controller enclosure, controller A is above controller B.

Front View

Figure 4-1 shows the front view of a 2 U 12-disk controller enclosure.

Figure 4-1 Front view of a 2 U 12-disk controller enclosure



- | | | | |
|---|---------------------------------|---|------------------------------|
| 1 | Disk module handle | 2 | Disk module latch |
| 3 | Controller enclosure ID display | 4 | Power indicator/Power button |

NOTE

- 1 The disk slots of a 2 U 12-disk controller enclosure are numbered 0 to 11 from left to right and from top to bottom. The four coffer disks are located in slot 0 to slot 3.
- 1 Slots are used to accommodate and secure disks, interface modules, controller modules, fan modules, and power modules.
- 1 The information plate records device information.

Rear View

Figure 4-2 shows the rear view of a controller enclosure.

NOTICE

Do not connect the management network port and maintenance network port to the same switch.

NOTE

- 1 Onboard GE ports are supported by the mRAID16 and onboard SmartIO ports are supported by the mRAID16.
- 1 A controller enclosure supports 8 Gbit/s Fibre Channel interface modules, GE electrical interface modules, 10GE electrical interface modules, 16 Gbit/s Fibre Channel interface modules, 10 Gbit/s TOE, 10 Gbit/s FCoE (two ports), 10 Gbit/s FCoE (four ports), 56 Gbit/s IB interface modules, SmartIO interface modules, High-Density 8 Gbit/s Fibre Channel interface modules and 12 Gbit/s SAS expansion modules. The following figure uses a 16 Gbit/s Fibre Channel interface module of mRAID16 as an example.
- 1 When the maintenance network port is used for management and maintenance, the maintenance network port can only be used by Active Storage technical support for emergency maintenance and cannot be connected to the same network with the management network port. Otherwise, a network loopback may occur, causing a network storm. The initial value for the IP address of the maintenance network port is 172.31.128.101 or 172.31.128.102. The default subnet mask is 255.255.0.0. You are advised to only connect the management network port to the network.

Figure 4-2 Rear view of a controller enclosure

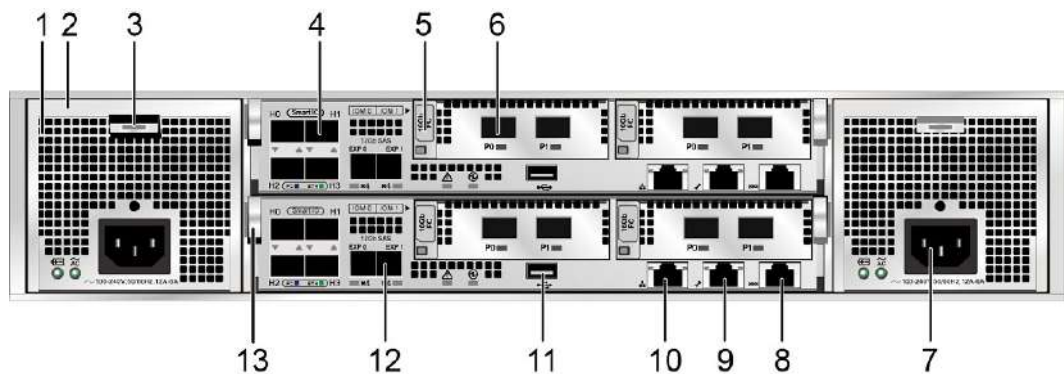

- | | | | |
|---|-------------------------|---|------------------------------|
| 1 | Power-BBU module | 2 | Power-BBU module handle |
| 3 | Power-BBU module latch | 4 | SmartIO port |
| 5 | Interface module handle | 6 | 16 Gbit/s Fibre Channel port |
| 7 | Power socket | 8 | Serial port |

9	Maintenance network port	10	Management network port
11	USB port	12	Mini SAS HD expansion port
13	Controller handle		

4.2.2 Component Description

This section provides the illustration and description of each component of the storage system.

4.2.2.1 System Enclosure

The system enclosure integrates a midplane in order to provide reliable connections for interface modules and to distribute power and signals to inner modules.

Appearance

Figure 4-3 shows the appearance of a system enclosure.

Figure 4-3 System enclosure



4.2.2.2 Controller

A controller is the core component of a storage system. It processes storage services, receives configuration management commands, saves configuration data, connects to disk enclosures, and saves critical data onto coffer disks.



NOTE

Each controller has one or more built-in disks to store system data. If a power failure occurs, such disks also store cache data. The disks built in one controller and those built in another are redundant for each other.

Appearance

Figure 4-4 shows the appearance of a controller.

Figure 4-4 Controller



Ports

As an example, Figure 4-5 describes the ports of a controller.

Figure 4-5 Controller

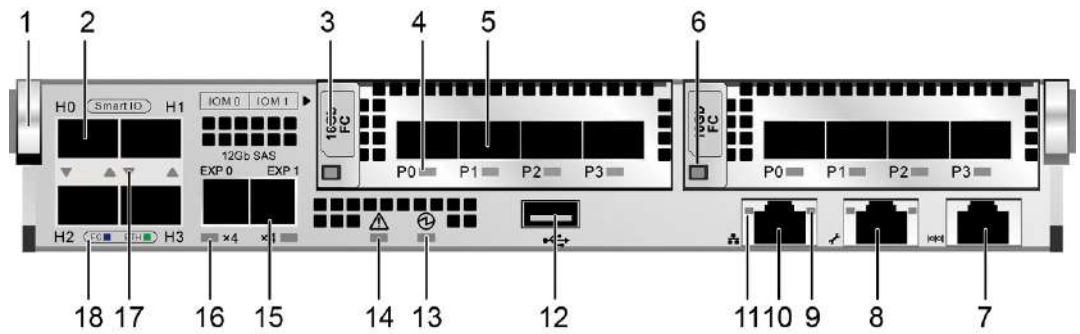

- | | | | |
|---|------------------------------|---|--|
| 1 | Controller handle | 2 | SmartIO port |
| 3 | Interface module handle | 4 | Link/Speed indicator of the 16 Gbit/s Fibre Channel port |
| 5 | 16 Gbit/s Fibre Channel port | 6 | Power indicator/Hot Swap button of the |

		module
7	Serial port	8 Maintenance network port
9	Link/Active indicator of the management network port	10 Management network port
11	Speed indicator of the management network port	12 USB port
13	Power indicator of the controller	14 Alarm indicator of the controller
15	Mini SAS HD expansion port	16 Mini SAS HD expansion port indicator
17	Link/Speed indicator of the SmartIO port	18 Port mode silkscreen

Indicators

As an example, Table 4-2 describes the states and corresponding meanings of indicators on a controller after it is powered on.

Table 4-2 Checklist for indicators on a controller

No.	Indicator	Status and Description
4	Link/Speed indicator of the 16 Gbit/s Fibre Channel port	<ul style="list-style-type: none"> 1 Steady blue: The data transfer rate between the storage system and the application server is 16 Gbit/s. 1 Blinking blue: Data is being transferred. 1 Steady green: The data transfer rate between the storage system and the application server is 8 Gbit/s or 4 Gbit/s. 1 Blinking green: Data is being transferred. 1 Steady red: The port is faulty. 1 Off: The link to the port is down.
6	Power indicator/Hot Swap button of the module	<ul style="list-style-type: none"> 1 Steady green: The interface module is working correctly. 1 Blinking green: There is a hot swap request to the module. 11 Steady red: The module is faulty. Off: The module is powered off.
9	Link/Active indicator of the management network port	<ul style="list-style-type: none"> 11 Steady green: The port is connected properly. 1 Blinking green: Data is being transferred. Off: The port is connected abnormally.
11	Speed indicator of the management network port	<ul style="list-style-type: none"> 1 Steady orange: Data is being transferred at the highest rate. 1 Off: The data transfer speed is lower than the highest speed.

No.	Indicator	Status and Description
13	Power indicator of the controller	<ul style="list-style-type: none"> ¹Steady green: The controller is powered on. ¹The Power indicator blinking green and the Alarm indicator blinking red: The controller is being located. ¹Blinking green (0.5 Hz): The controller is powered on and in the BIOS boot process, or is powered off. ¹Blinking green (2 Hz): The controller is in the operating system boot process. ¹Off: The controller is absent or powered off.
14	Alarm indicator of the controller	<ul style="list-style-type: none"> ¹Steady red: An alarm is generated on the controller. ¹The Alarm indicator blinking red and the Power indicator blinking green: The controller is being located. ¹Off: The controller is working correctly.
16	Mini SAS HD expansion port indicator	<ul style="list-style-type: none"> ¹Steady blue: The data transfer rate between the controller enclosure and the disk enclosure is 4 x 12 Gbit/s. ¹Steady green: The data transfer rate between the controller enclosure and the disk enclosure is 4 x 6 Gbit/s or 4 x 3 Gbit/s. ¹Steady red: The port is faulty. ¹Off: The link is down.
17	Link/Speed indicator of the SmartIO port	<ul style="list-style-type: none"> ¹Blinking blue slowly: The interface module is working in FC mode, and the port link is down. ¹Blinking blue quickly: The interface module is working in FC mode, and data is being transmitted. ¹Steady blue: The interface module is working in FC mode, the port link is up, and no data is being transmitted. ¹Blinking green slowly: The interface module is working in ETH mode, and the port link is down. ¹Blinking green quickly: The interface module is working in ETH mode, and data is being transmitted. ¹Steady green: The interface module is working in ETH mode, the port link is up, and no data is being transmitted.

Indicators

Table 4-3 describes indicators on a 16 Gbit/s Fibre Channel interface module of a storage system that is powered on.

Table 4-3 Indicators on a 16 Gbit/s Fibre Channel interface module

No.	Indicator	Status and Description
1	Power indicator/Hot Swap button on the interface module	<ul style="list-style-type: none"> ¹ Steady green: The interface module is working correctly. ¹ Blinking green: There is a hot swap request to the module. ¹ Steady red: The module is faulty. ¹ Off: The interface module is powered off or hot swappable.
3	Link/Speed indicator of the 16 Gbit/s Fibre Channel port	<ul style="list-style-type: none"> ¹ Steady blue: The data transfer rate between the storage system and the application server is 16 Gbit/s. ¹ Blinking blue: Data is being transferred. ¹ Steady green: The data transfer rate between the storage system and the application server is 8 Gbit/s or 4 Gbit/s. ¹ Blinking green: Data is being transferred. ¹ Steady red: The port is faulty. ¹ Off: The link to the port is down.

4.2.2.3 8/16 Gbit/s Fibre Channel Interface Module

Interface modules connect storage devices to application servers.

Function

An 8/16 Gbit/s Fibre Channel interface module provides four 8/16 Gbit/s Fibre Channel ports. These ports are service ports used to connect a storage system to application servers and receive data read/write requests from application servers. If the data transfer rate of an application server connected to such a port is lower than the port rate and the port mode is set to autonegotiation, the port automatically adjusts its rate to ensure the connectivity of the data transfer channel and the consistency of the data transfer rate. If the port rate is manually set but inconsistent with the data transfer rate of the connected application server, the connection is interrupted.

Ports

Figure 4-6 shows the appearance of an 8/16 Gbit/s Fibre Channel interface module.

Figure 4-6 8/16 Gbit/s Fibre Channel interface module

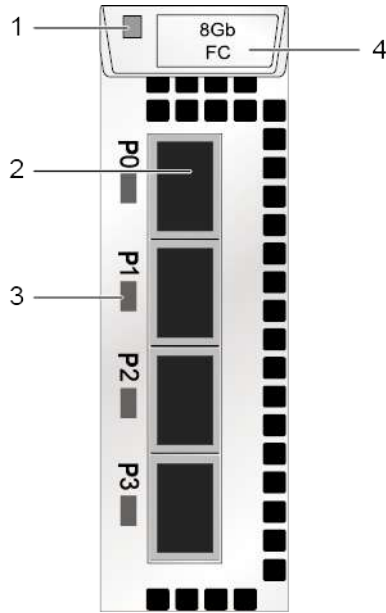

- | | | | |
|---|--|---|--------------------------------|
| 1 | Power indicator/Hot Swap button on the module | 2 | 8/16 Gbit/s Fibre Channel port |
| 3 | Link/Speed indicator of an 8 Gbit/s Fibre Channel port | 4 | Module handle |

Indicators

Table 4-4 describes the indicators on an 8 Gbit/s Fibre Channel interface module of a storage system that is powered on.

Table 4-4 Indicators on an 8 Gbit/s Fibre Channel interface module

No.	Indicators	Status and Description
1	Power indicator/Hot Swap button on the module	<ul style="list-style-type: none"> ¹ Steady green: The interface module is working correctly. ¹ Blinking green: The interface module receives a hot swap request. ¹ Steady red: The interface module is faulty. ¹ Off: The interface module is powered off or hot swappable.
3	Link/Speed indicator of an 8/16 Gbit/s Fibre Channel port	<ul style="list-style-type: none"> ¹ Steady blue: The data transfer rate between the storage system and the application server is 8 Gbit/s. ¹ Blinking blue: Data is being transferred. ¹ Steady green: The data transfer rate between the storage system and the application server is 4 or 2 Gbit/s.

No.	Indicators	Status and Description
		<ul style="list-style-type: none"> 1 Blinking green: Data is being transferred. 1 Steady red: The port is faulty. 1 Off: The link to the port is down.

4.2.2.4 10GE Electrical Interface Module

Interface modules connect storage devices to application servers.

Function

A 10GE electrical interface module has four 10 Gbit/s electrical ports. These ports are the service ports used to connect the storage system to application servers and to receive data read/write requests from application servers.

Ports

Figure 4-7 shows the appearance of a 10GE electrical interface module.

Figure 4-7 10GE electrical interface module

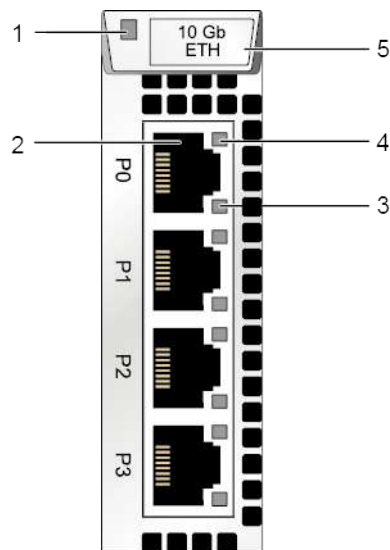

- | | |
|---|---|
| 1 Power indicator/Hot Swap button on the interface module | 2 10GE electrical port |
| 3 Link/Active indicator of the 10GE electrical port | 4 Speed indicator of the 10GE electrical port |
| 5 Interface module handle | |



NOTE

Adaptive connections cannot be implemented between 10GE electrical ports and GE electrical ports of the storage system.

Indicators

Table 4-5 describes indicators on a 10GE electrical interface module of a powered-on storage system.

Table 4-5 Indicators on a 10GE electrical interface module

No.	Indicator	Status and Description
1	Power indicator/Hot Swap button on the interface module	<ul style="list-style-type: none"> 1 Steady green: The interface module is working correctly. 1 Blinking green: There is a hot swap request to the module. 11 Steady red: The module is faulty. Off: The module is powered off or hot swappable.
3	Link/Active indicator of the 10GE electrical port	<ul style="list-style-type: none"> 1 Steady green: The link to the server is normal. 1 Blinking green: Data is being transferred. 1 Off: The link to the application server is down or no link exists.
4	Speed indicator of the 10GE electrical port	<ul style="list-style-type: none"> 1 Steady orange: The data transfer rate of the management network port is 10 Gbit/s. 1 Off: The data transfer rate of the management network port is less than 10 Gbit/s.

4.2.2.5 GE Electrical Interface Module

Interface modules connect storage devices to application servers.

Function

A GE electrical interface module has four 1 Gbit/s electrical ports. These ports are the service ports used to connect the storage system to application servers and to receive data read/write requests from application servers.

Ports

Figure 4-8 shows the appearance of a GE electrical interface module.

Figure 4-8 GE electrical interface module

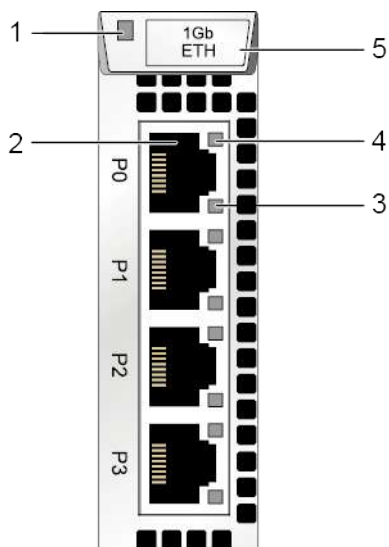

- 1 Power indicator/Hot Swap button on the interface module
- 2 GE electrical port
- 3 Link/Active indicator of the GE electrical port
- 4 Speed indicator of the GE electrical port
- 5 Interface module handle

Indicators

Table 4-6 describes indicators on a GE electrical interface module of a powered-on storage system.

Table 4-6 Indicators on a GE electrical interface module

No.	Indicator	Status and Description
1	Power indicator/Hot Swap button on the interface module	<ul style="list-style-type: none"> 1 Steady green: The interface module is working correctly. 1 Blinking green: There is a hot swap request to the module. 11 Steady red: The module is faulty. Off: The interface module is powered off or hot swappable.
3	Link/Active indicator of the GE electrical port	<ul style="list-style-type: none"> 1 Steady green: The link to the server is normal. 1 Blinking green: Data is being transferred. 1 Off: The link to the application server is down or no link exists.
4	Speed indicator of the GE electrical port	<ul style="list-style-type: none"> 1 Steady orange: The data transfer rate between the storage system and the application server is 1 Gbit/s.

No.	Indicator	Status and Description
		¹ Off: The data transfer rate between the storage system and the application server is less than 1 Gbit/s.

4.2.2.6 10 Gbit/s TOE Interface Module

Interface modules connect storage devices to application servers.

Function

A 10 Gbit/s TOE interface module provides four 10 Gbit/s TOE ports. These ports are service ports used to connect a storage system to application servers and receive data read/write requests from application servers.

Ports

Figure 4-9 shows the appearance of a 10 Gbit/s TOE interface module.

Figure 4-9 10 Gbit/s TOE interface module

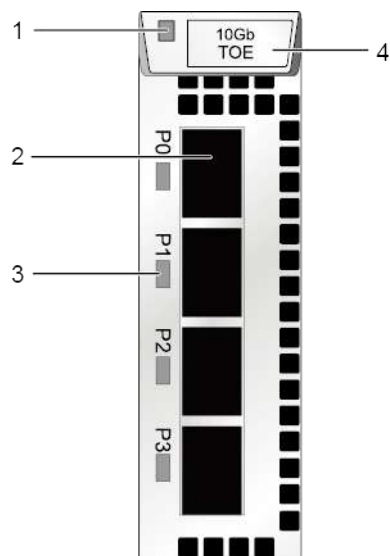

- | | | | |
|---|---|---|--------------------|
| 1 | Power indicator/Hot Swap button on the module | 2 | 10 Gbit/s TOE port |
| 3 | Link/Speed indicator of a 10 Gbit/s TOE port | 4 | Module handle |

Indicators

Table 4-7 describes the indicators on a 10 Gbit/s TOE interface module of a storage system that is powered on.

Table 4-7 Indicators on a 10 Gbit/s TOE interface module

No.	Indicators	Status and Description
1	Power indicator/Hot Swap button on the module	<ul style="list-style-type: none"> 1 Steady green: The interface module is working correctly. 1 Blinking green: The interface module receives a hot swap request. 1 Steady red: The interface module is faulty. 1 Off: The interface module is powered off or hot swappable.
3	Link/Speed indicator of a 10 Gbit/s TOE port	<ul style="list-style-type: none"> 1 Steady blue: The data transfer rate between the storage system and the application server is 10 Gbit/s. 1 Blinking blue: Data is being transferred. 1 Steady red: The port is faulty. 1 Off: The link to the port is down.

4.2.2.7 10 Gbit/s FCoE Interface Module (Four Ports)

Interface modules connect storage devices to application servers.

Function

A 10 Gbit/s FCoE interface module provides four 10 Gbit/s FCoE ports. These ports are service ports used to connect a storage system to application servers and receive data read/write requests from application servers.

Ports

Figure 4-10 shows the appearance of a 10 Gbit/s FCoE interface module.

Figure 4-10 10 Gbit/s FCoE interface module

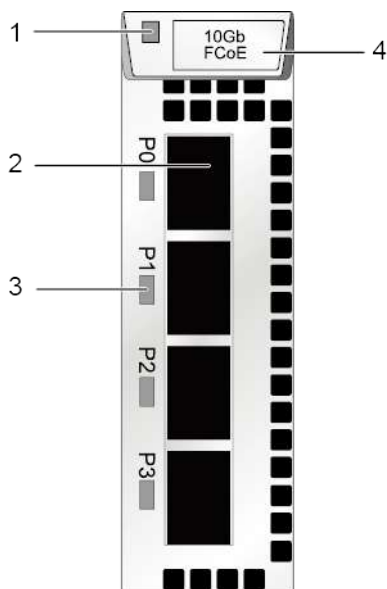

- | | | | |
|---|---|---|---------------------|
| 1 | Power indicator/Hot Swap button on the module | 2 | 10 Gbit/s FCoE port |
| 3 | Link/Speed indicator of a 10 Gbit/s FCoE port | 4 | Module handle |

Indicators

Table 4-8 describes the indicators on a 10 Gbit/s FCoE interface module of a storage system that is powered on.

Table 4-8 Indicators on a 10 Gbit/s FCoE interface module

No.	Indicators	Status and Description
1	Power indicator/Hot Swap button on the module	<ul style="list-style-type: none"> 1 Steady green: The interface module is working correctly. 1 Blinking green: The interface module receives a hot swap request. 1 Steady red: The interface module is faulty. 1 Off: The interface module is powered off or hot swappable.
3	Link/Speed indicator of a 10 Gbit/s FCoE port	<ul style="list-style-type: none"> 1 Steady blue: The data transfer rate between the storage system and the application server is 10 Gbit/s. 1 Blinking blue: Data is being transferred. 1 Steady red: The port is faulty. 1 Off: The link to the port is down.

4.2.2.8 56 Gbit/s IB Interface Module

Interface modules connect storage devices to application servers.

Function

A 56 Gbit/s IB (InfiniBand) interface module provides two 4 x 14 Gbit/s IB ports. Both are the service ports used to connect to application servers and to receive data read/write requests from application servers.

Interface

Figure 4-11 shows the appearance of a 56 Gbit/s IB interface module.

Figure 4-11 56 Gbit/s IB interface module

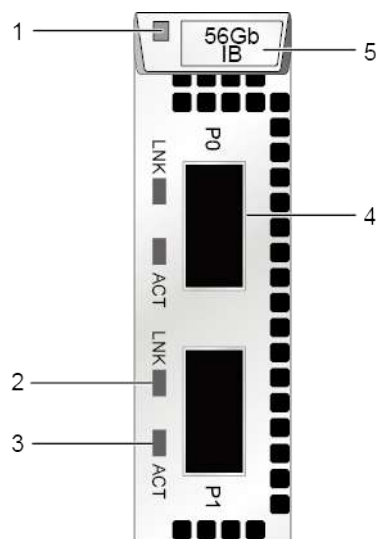

- | | | | |
|---|------------------------------------|---|----------------------------------|
| 1 | Module Power indicator | 2 | 56 Gbit/s IB port Link indicator |
| 3 | 56 Gbit/s IB port Active indicator | 4 | 56 Gbit/s IB port |
| 5 | Module handle | | |

Indicators

Table 4-9 describes the states of indicators and their meanings on a 56 Gbit/s IB interface module after the storage device is powered on.

Table 4-9 Indicator status description for a 56 Gbit/s IB interface module

No.	Indicator	Status Description
1	Module Power indicator	¹ Steady green: The interface module is running properly. ¹ Blinking green: The interface module receives a hot swap request.

No.	Indicator	Status Description
		11 Steady red: The interface module is faulty. Off: The interface module is not powered on or can be hot-swapped.
2	56 Gbit/s IB port Link indicator	1 Steady green: The port is connected properly. 1 Off: The port link is down.
3	56 Gbit/s IB port Active indicator	1 Steady orange: Data is being transmitted. 1 Off: No data is being transmitted.

4.2.2.9 SmartIO Interface Module

Interface modules are mainly used to connect storage devices to application servers.

Function

A SmartIO interface module provides 16 Gbit/s, 8 Gbit/s, and 10 Gbit/s optical transceiver. They are the service ports used to connect to application servers and to receive data read/write requests from application servers.

Interface

Figure 4-12 shows the components of a SmartIO interface module.

Figure 4-12 SmartIO interface module

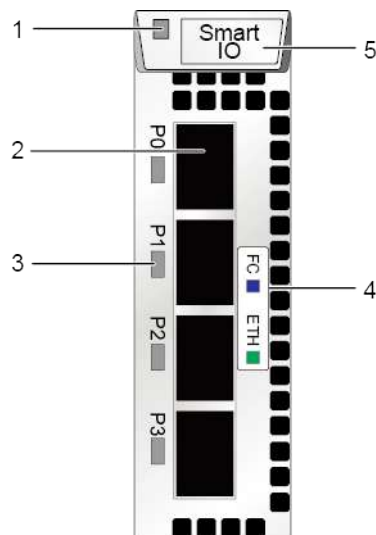

- | | | | |
|---|---------------------------------|---|----------------------|
| 1 | Module Power/Hot Swap indicator | 2 | SmartIO port |
| 3 | Port Link/Active/Mode indicator | 4 | Port mode silkscreen |
| 5 | Module handle | | |

Indicators

Table 4-10 describes the states of indicators and their meanings on a SmartIO interface module after the storage device is powered on.

Table 4-10 Indicator status description for a SmartIO interface module

No.	Indicator	Status Description
1	Module Power/Hot Swap button	<ul style="list-style-type: none"> ¹ Steady green: The interface module is running properly. ¹ Blinking green: The interface module receives a hot swap request. ¹ Steady red: The interface module is faulty. ¹ Off: The interface module is not powered on or can be hot-swapped.
3	Port Link/Active/Mode indicator	<ul style="list-style-type: none"> ¹ Blinking blue slowly: The interface module is working in FC mode, and the port link is down. ¹ Blinking blue quickly: The interface module is working in FC mode, and data is being transmitted. ¹ Steady blue: The interface module is working in FC mode, the port link is up, and no data is being transmitted. ¹ Blinking green slowly: The interface module is working in ETH mode, and the port link is down. ¹ Blinking green quickly: The interface module is working in ETH mode, and data is being transmitted. ¹ Steady green: The interface module is working in ETH mode, the port link is up, and no data is being transmitted. ¹ Steady red: The port is faulty. ¹ Blinking red: The port is being located. ¹ Off: The port is not powered on.



NOTE

- ¹ If the mode of the SmartIO port is set to **FCoE/iSCSI** or **Cluster** on the software interface, the port indicator is in ETH mode.
- ¹ If the mode of the SmartIO port is set to **FC** on the software interface, the port indicator is in FC mode.

4.2.2.10 12 Gbit/s SAS Expansion Module

An expansion module provides expansion ports that are used for communication between a controller enclosure and a disk enclosure. The module transfers data between a controller enclosure and a disk enclosure.

Function

A SAS interface module provides four 4 x 12 Gbit/s mini SAS HD expansion ports that provide connectivity to disk enclosures. The SAS interface module connects to the back-end storage array of the storage system through a mini SAS HD cable. When the transfer rate of the connected device is less than that of the expansion port, the expansion port automatically adjusts the transfer rate to that of the connected device to ensure the connectivity of the data transfer channel.

Ports

Figure 4-13 shows the appearance of a 12 Gbit/s SAS expansion module.

Figure 4-13 12 Gbit/s SAS expansion module

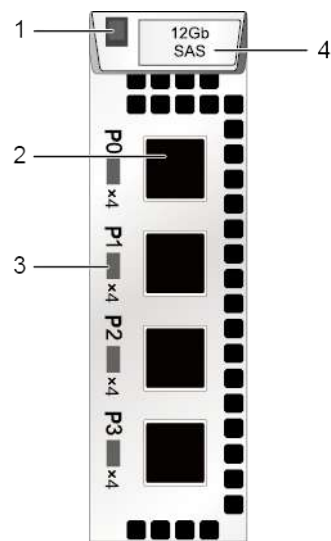

- | | | | |
|---|---|---|----------------------------|
| 1 | Power indicator/Hot Swap button of the module | 2 | Mini SAS HD expansion port |
| 3 | Mini SAS HD expansion port indicator | 4 | Module handle |

Indicators

Table 4-11 describes indicators on a 12 Gbit/s SAS expansion module of a powered-on storage system.

Table 4-11 Indicators on a 12 Gbit/s SAS expansion module

No.	Indicator	Status and Description
1	Power indicator/Hot Swap button of the module	¹ Steady green: The interface module is working correctly. ¹ Blinking green: There is a hot swap request to the module. ¹ Steady red: The module is faulty. ¹ Off: The interface module is powered off or

No.	Indicator	Status and Description
		hot swappable.
3	Mini SAS HD expansion port indicator	¹ Steady blue: The data transfer rate between the mini SAS expansion port and the expansion enclosure is 4 x 12 Gbit/s. ¹ Steady green: The data transfer rate between the mini SAS expansion port and the expansion enclosure is 4 x 6 Gbit/s or 4 x 3 Gbit/s. ¹ Steady red: The port is faulty. ¹ Off: The link to the port is down.

4.2.2.11 Power-BBU Module

A power-BBU module consists of a power module and a BBU. Power modules are classified into AC power modules and DC power modules. Power modules can ensure that the controller enclosure works correctly in maximum power consumption mode. BBUs provide backup power when the external power supply of the system fails to ensure the integrity of the service data on the storage array. If a BBU is faulty, it can be isolated, ensuring the normal running of the storage system. If a power failure occurs, BBUs ensure that the storage system writes cached data to the build-in disks of the controllers, preventing data loss. After the external power supply resumes, the driver reads data from the build-in disks of the controllers.

Appearance

Figure 4-14, Figure 4-15, and Figure 4-16 show the front view of an AC power-BBU module, the front view of a DC power-BBU module, and the rear view of a power-BBU module respectively.

Figure 4-14 Front view of an AC power-BBU module

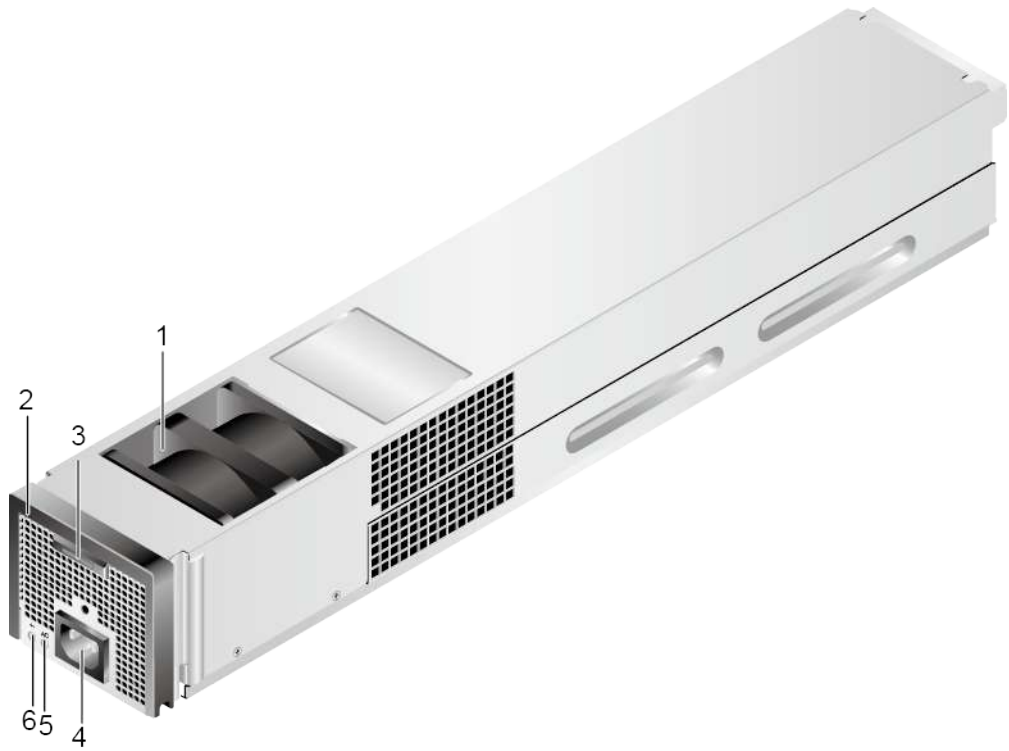

- | | | | |
|---|---|---|------------------------------------|
| 1 | Fan built in the power-BBU module | 2 | Power-BBU module handle |
| 3 | Power-BBU module latch | 4 | Power module socket |
| 5 | Running/Alarm indicator of the power module | 6 | Running/Alarm indicator of the BBU |

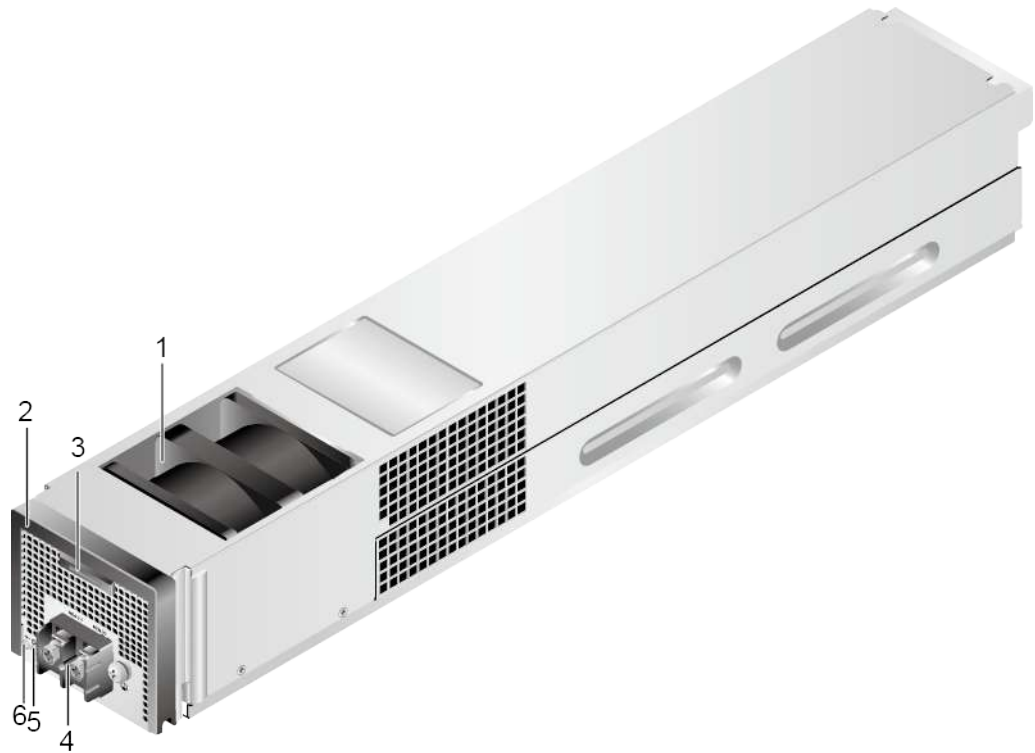
Figure 4-15 Front view of a DC power-BBU module

- | | | | |
|---|---|---|---|
| 1 | Fan built in the power-BBU module | 2 | Power-BBU module handle |
| 3 | Power-BBU module latch | 4 | Positive and negative terminals of the power module |
| 5 | Running/Alarm indicator of the power module | 6 | Running/Alarm indicator of the BBU |

Figure 4-16 Rear view of a power-BBU module



1 Power module

2 BBU

Indicators

Table 4-12 describes indicators on a power-BBU module of a powered-on storage system.

Table 4-12 Indicators on a power-BBU module

No.	Indicator	Status and Description
5	Running/Alarm indicator of the power module	<ul style="list-style-type: none"> ¹ Steady green: The power supply is correct. ¹ Green blinking: The power input is normal but the disk enclosure is powered off. ¹ Steady red: The power supply is faulty. ¹ Off: No external power input is found.
6	Running/Alarm indicator of the BBU	<ul style="list-style-type: none"> ¹ Steady green: The BBU is fully charged. ¹ Blinking green (1 Hz): The BBU is being charged. ¹ Blinking green (4 Hz): The BBU is being discharged. ¹ Steady red: The BBU is faulty.

4.2.2.12 Disk Module

Disk modules provide storage capacity for a storage system. Service data, system data, and cache data are all saved on disk modules.

Appearance

Figure 4-17 shows the appearance of a 3.5-inch disk module.

Figure 4-17 Disk module



- 1 Disk module handle
- 2 Disk module latch
- 3 Alarm/Location indicator of the disk module
- 4 Running indicator of the disk module
- 5 Disk tray
- 6 Disk

Indicators

Table 4-13 describes indicators on a disk module of a powered-on storage system.

Table 4-13 Indicators on a disk module

No.	Indicator	Status and Description
4	Running indicator of the disk module	1Steady green: The disk module is working correctly. 1Blinking green: Data is being read and written on the disk module. 1Off: The disk module is powered off or

No.	Indicator	Status and Description
		powered on incorrectly.
3	Alarm/Location indicator of the disk module	1Steady red: The disk module is faulty. 1Blinking red: The disk module is being located. 1Off: The disk module is working correctly or hot swappable.

4.2.3 Indicator Introduction

After a controller enclosure is powered on, you can check the current operating status of the controller enclosure by viewing its indicators.

Indicators on the Front Panel

Figure 4-18 shows the indicators on the front panel of a 2 U 12-disk controller enclosure.

Figure 4-18 Indicators on the front panel of a 2 U 12-disk controller enclosure

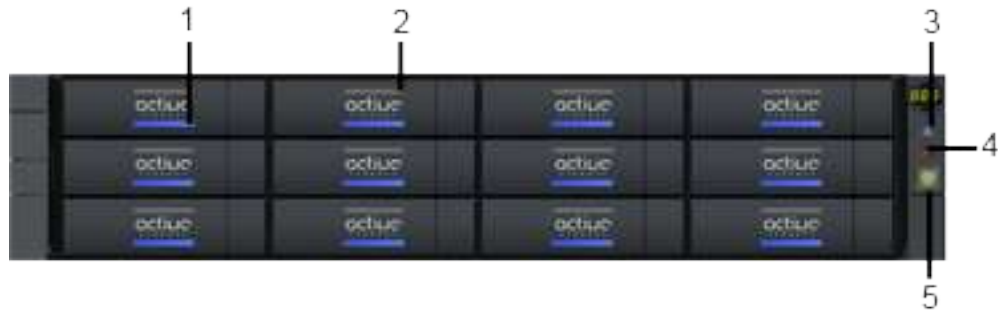

- | | | | |
|---|--|---|---|
| 1 | Running indicator of the disk module | 2 | Location/Alarm indicator of the disk module |
| 3 | Location indicator of the controller enclosure | 4 | Alarm indicator of the controller enclosure |
| 5 | Power indicator/Power button of the controller enclosure | | |

Table 4-14 describes the indicators on the front panel of the controller enclosure.

Table 4-14 Description of the indicators on the front panel of a controller enclosure

Module	No.	Indicator	Status and Description
Disk module	1	Running indicator of the disk module	1Steady green: The disk module is working correctly. 1Blinking green: Data is being read and written on the disk

Module	No.	Indicator	Status and Description
			module. ¹ Off: The disk module is powered off or powered on incorrectly.
	2	Alarm/Location indicator of the disk module	¹ Steady red: The disk module is faulty. ¹ Blinking red: The disk module is being located. ¹ Off: The disk module is working correctly or hot swappable.
System enclosure	3	Location indicator of the controller enclosure	¹ Blinking blue: The controller enclosure is being located. ¹ Off: The controller enclosure is not located.
	4	Alarm indicator of the controller enclosure	¹ Steady red: The controller enclosure is out of service, or an alarm is generated on it. ¹ Off: The controller enclosure is working correctly.
	5	Power indicator/Power button of the controller enclosure	¹ Steady green: The controller enclosure is powered on. ¹ Blinking green (0.5 Hz): The controller enclosure is being powered on. ¹ Blinking green (1 Hz): The controller enclosure is in the burn-in test. ¹ Blinking green (2 Hz): The controller enclosure is in the operating system boot process, or is being powered off. ¹ Off: The controller enclosure is powered off or powered by the BBUs.

Indicators on the Rear Panel

Figure 4-19 shows the indicators on the rear panel of a controller enclosure.



NOTE

The following figure shows the indicators on the mRAID16.

Figure 4-19 Indicators on the rear panel of a controller enclosure

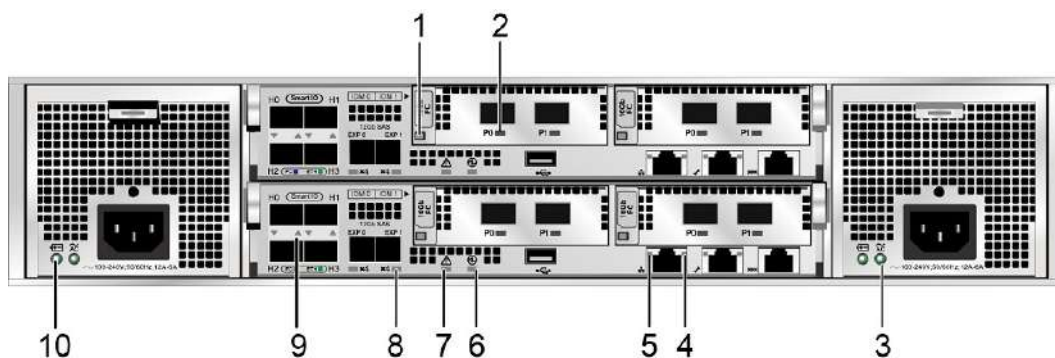

- | | | | |
|---|--|----|--|
| 1 | Power indicator/Hot Swap button of the module | 2 | Link/Speed indicator of the 16 Gbit/s Fibre Channel port |
| 3 | Running/Alarm indicator of the power module | 4 | Link/Active indicator of the management network port |
| 5 | Speed indicator of the management network port | 6 | Power indicator of the controller |
| 7 | Alarm indicator of the controller | 8 | Mini SAS HD expansion port indicator |
| 9 | Link/Speed indicator of the SmartIO port | 10 | Running/Alarm indicator of the BBU port |

Table 4-15 describes the indicators on the rear panel of the controller enclosure.

Table 4-15 Description of the indicators on the rear panel of a controller enclosure

Module	No.	Indicator	Status and Description
Interface module	1	Power indicator/Hot Swap button on the interface module	<ul style="list-style-type: none"> 1 Steady green: The interface module is working correctly. 1 Blinking green: The interface module receives a hot swap request. 11 Steady red: The interface module is faulty. Off: The interface module is powered off.
	2	Link/Speed indicator of the 16 Gbit/s Fibre Channel port	<ul style="list-style-type: none"> 1 Steady blue: The data transfer rate is 16 Gbit/s. 1 Blinking blue: Data is being transferred. 1 Steady green: The data transfer rate is 8 Gbit/s or 4 Gbit/s. 1 Blinking green: Data is being transferred. 1 Steady red: The port is faulty. 1 Off: The link to the port is down.
Power-BBU module	3	Running/Alarm indicator of the power module	<ul style="list-style-type: none"> 11 Steady green: The power supply is correct. Blinking green: The power input is normal but the disk enclosure is powered off.

Module	No.	Indicator	Status and Description
			<ul style="list-style-type: none"> 1 Steady red: The power module is faulty. 1 Off: No external power input is found.
Controller	4	Link/Active indicator of the management network port	<ul style="list-style-type: none"> 1 Steady green: The port is connected properly. 1 Blinking green: Data is being transferred. 1 Off: The port is connected abnormally.
	5	Speed indicator of the management network port	<ul style="list-style-type: none"> 1 Steady orange: Data is being transferred at the highest rate. 1 Off: The data transfer speed is lower than the highest speed.
	6	Power indicator of the controller	<ul style="list-style-type: none"> 11 Steady green: The controller is powered on. The Power indicator blinking green and the Alarm indicator blinking red: The controller is being located. 1 Blinking green (0.5 Hz): The controller enclosure is powered on and in the BIOS boot process. 1 Blinking green (2 Hz): The controller is in the operating system boot process, or the controller is in the power-off process. 1 Off: The controller is powered off.
	7	Alarm indicator of the controller	<ul style="list-style-type: none"> 1 Steady red: An alarm is generated on the controller. 1 The Alarm indicator blinking red and the Power indicator blinking green: The controller is being located. 1 Off: The controller is working correctly.
	8	Mini SAS HD expansion port indicator	<ul style="list-style-type: none"> 1 Steady blue: Data is transferred to the upstream disk enclosure at the rate of 4 x 12 Gbit/s. 1 Steady green: Data is transferred to the downstream disk enclosure at the rate of 4 x 6 Gbit/s or 4 x 3 Gbit/s. 11 Steady red: The port is faulty. Off: The link to the port is down.
	9 ^a	Link/Speed indicator of the SmartIO port	<ul style="list-style-type: none"> 1 Blinking blue slowly: The interface module is working in FC mode, and the port link is down. 1 Blinking blue quickly: The interface module is working in FC mode, and data is being transmitted. 1 Steady blue: The interface module is working in FC mode, the port link is up, and no data is being transmitted. 1 Blinking green slowly: The interface module is

Module	No.	Indicator	Status and Description
			<p>working in ETH mode, and the port link is down.</p> <p>‡Blinking green quickly: The interface module is working in ETH mode, and data is being transmitted.</p> <p>‡Steady green: The interface module is working in ETH mode, the port link is up, and no data is being transmitted.</p>
Power-BBU module	10	Running/Alarm indicator of the BBU	<p>‡Steady green: The BBU is fully charged.</p> <p>‡Blinking green (1 Hz): The BBU is being charged.</p> <p>‡Blinking green (4 Hz): The BBU is being discharged.</p> <p>‡Steady red: The BBU is faulty.</p>
<p>When the onboard port is a GE electrical port, the indicators on both sides of the port are the Speed indicator and Link/Active indicator. For details about these indicators, see 4 and 5.</p>			

4.3 4 U Disk Enclosure (3.5-Inch Disks)

This chapter describes a disk enclosure in terms of its hardware structure, component functions, front and rear views, and indicators.

4.3.1 Overview

The disk enclosure consists of a system enclosure, expansion modules, disk modules, and power modules.

Overall Structure

Figure 4-20 shows the overall structure of a 4 U disk enclosure.

Figure 4-20 Overall structure of a 4 U disk enclosure

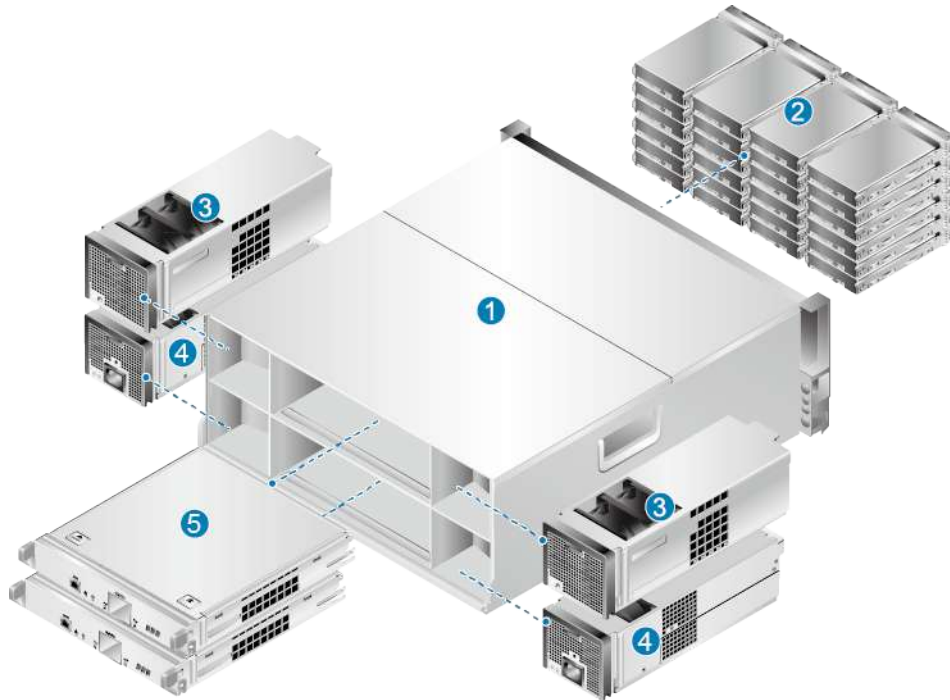

- | | | | |
|---|------------------|---|--------------|
| 1 | System enclosure | 2 | Disk module |
| 3 | Fan module | 4 | Power module |
| 5 | Expansion module | | |

Front View

Figure 4-21 shows the front view of a 4 U SAS disk enclosure.

Figure 4-21 Front view of a 4 U SAS disk enclosure



- | | | | |
|---|----------------------------------|---|----------------------------|
| 1 | Disk module handle | 2 | 3.5-Inch disk module latch |
| 3 | ID display of the disk enclosure | | |

**NOTE**

The disk slots of a 4 U SAS disk enclosure are numbered 0 to 23 from left to right and from top to bottom.

Rear View

Figure 4-22 shows the rear view of a disk enclosure.

Figure 4-22 Rear view of a disk enclosure

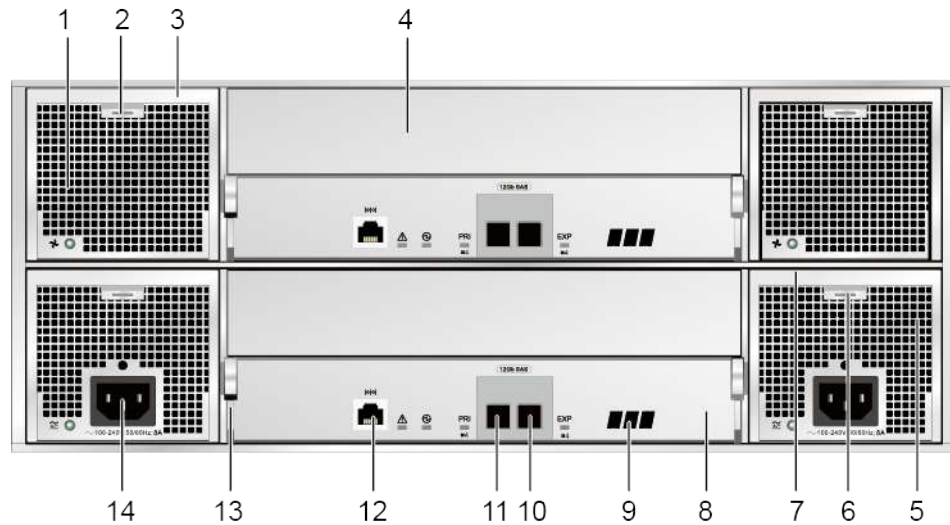

- | | | | |
|----|--------------------------------|----|--------------------------------|
| 1 | Fan module | 2 | Fan module latch |
| 3 | Fan module handle | 4 | Filler panel |
| 5 | Power module | 6 | Power module latch |
| 7 | Power module handle | 8 | Expansion module |
| 9 | Disk enclosure ID display | 10 | Mini SAS HD EXP expansion port |
| 11 | Mini SAS HD PRI expansion port | 12 | Serial port |
| 13 | Expansion module handle | 14 | Power socket |

4.3.2 Component Description

This section provides the illustration and description of each component of the storage system.

4.3.2.1 System Enclosure

The system enclosure integrates a midplane in order to provide reliable connections for interface modules and to distribute power and signals to inner modules.

Appearance

Figure 4-23 shows the appearance of a system enclosure.

Figure 4-23 System enclosure



4.3.2.2 Expansion Module

An expansion module provides expansion ports for communication between the disk enclosure and the controller enclosure. Each expansion module provides a PRI expansion port and an EXP expansion port.

Appearance

Figure 4-24 shows the appearance of an expansion module.

Figure 4-24 Expansion module



Ports

Figure 4-25 shows the ports of an expansion module.

Figure 4-25 Interfaces of an expansion module

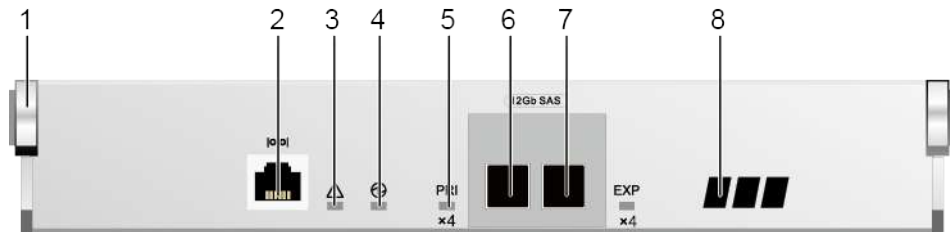

- | | | | |
|---|---|---|---|
| 1 | Expansion module handle | 2 | Serial port |
| 3 | Alarm indicator of the expansion module | 4 | Power indicator of the expansion module |
| 5 | Mini SAS HD expansion port indicator | 6 | Mini SAS HD PRI expansion port |
| 7 | Mini SAS HD EXP expansion port | 8 | Disk enclosure ID display |

Indicators

Table 4-16 describes indicators on an expansion module of a powered-on storage system.

Table 4-16 Indicators on an expansion module

No.	Indicator	Status and Description
-----	-----------	------------------------

No.	Indicator	Status and Description
3	Alarm indicator of the expansion module	¹ Steady red: An alarm is generated in the expansion module. ¹ Off: The expansion module is working correctly.
4	Power indicator of the expansion module	¹ Steady green: The expansion module is powered on. ¹ Off: The expansion module is powered off.
5	Mini SAS HD expansion port indicator	¹ Steady green: The link to the expansion port is normal and the data transfer rate is 4 x 6 Gbit/s or 4 x 3 Gbit/s. ¹ Steady blue: The link to the expansion port is normal and the data transfer rate is 4 x 12 Gbit/s. ¹ Steady red: The port is faulty. ¹ Off: The link to the expansion port is down.

4.3.2.3 Power Module

The storage system supports AC and DC power modules. Power modules can ensure that the disk enclosure works correctly in maximum power consumption mode.

Appearance

Figure 4-26 shows the appearance of an AC power module, Figure 4-27 shows the appearance of an DC power module.

Figure 4-26 AC power module

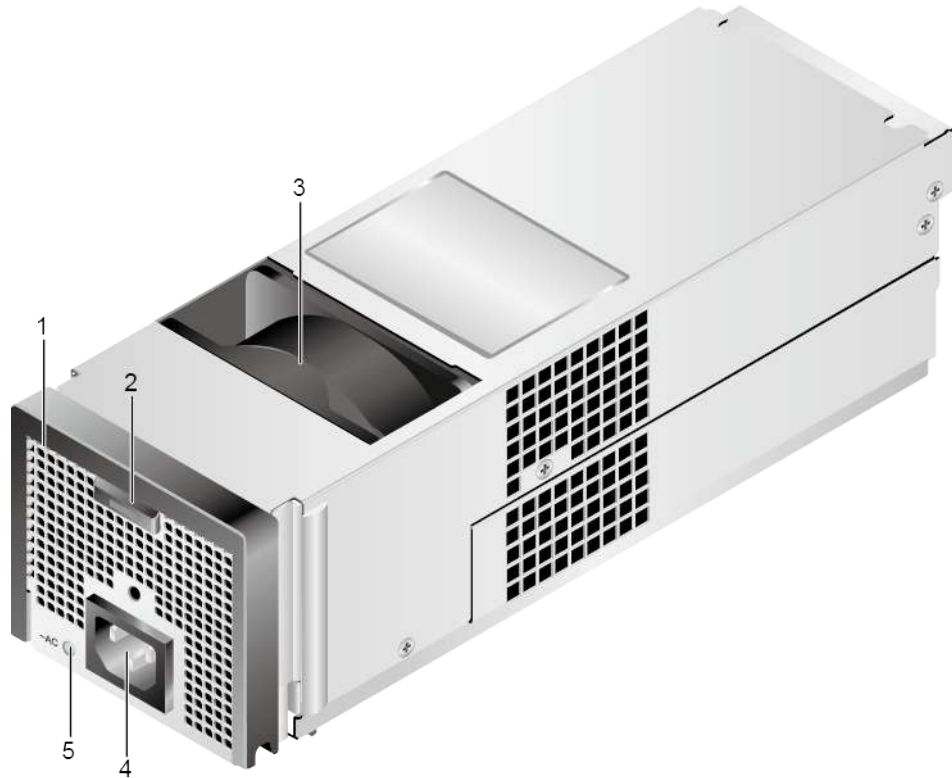

- | | | | |
|---|---|---|---------------------|
| 1 | Power module handle | 2 | Power module latch |
| 3 | Fan built in the power module | 4 | Power module socket |
| 5 | Running/Alarm indicator of the power module | | |

Figure 4-27 DC power module

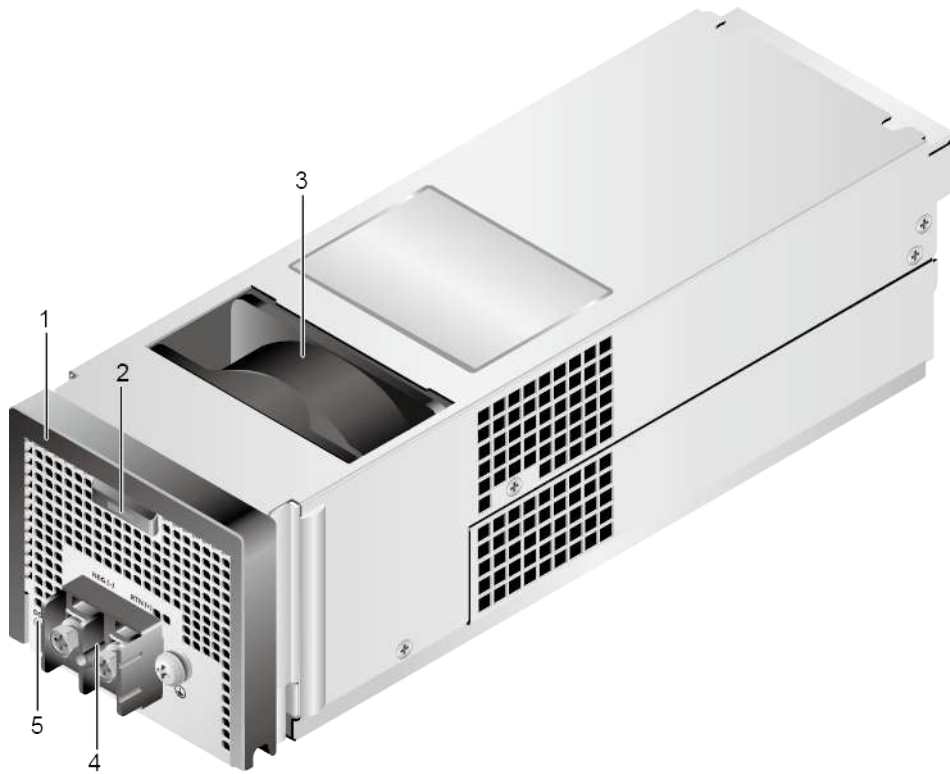

- 1 Power module handle
- 2 Power module latch
- 3 Fan built in the power module
- 4 Positive and negative terminals of the power module
- 5 Running/Alarm indicator of the power module



NOTE

When used for mRAID16, disk enclosures support DC power modules.

Indicators

Table 4-17 describes indicators on a power module of a powered-on storage system.

Table 4-17 Indicators on a power module

No.	Indicator	Status and Description
5	Running/Alarm indicator of the power module	<ul style="list-style-type: none"> ¹ Steady green: The power supply is correct. ¹ Blinking green: The power input is normal but the disk enclosure is powered off. ¹ Steady red: The power module is faulty. ¹ Off: No external power input is found.

4.3.2.4 Fan Module

A fan module provides heat dissipation and supports the normal running of the disk enclosure in maximum power consumption mode.

Appearance

Figure 4-28 shows the appearance of a fan module.

Figure 4-28 Fan module

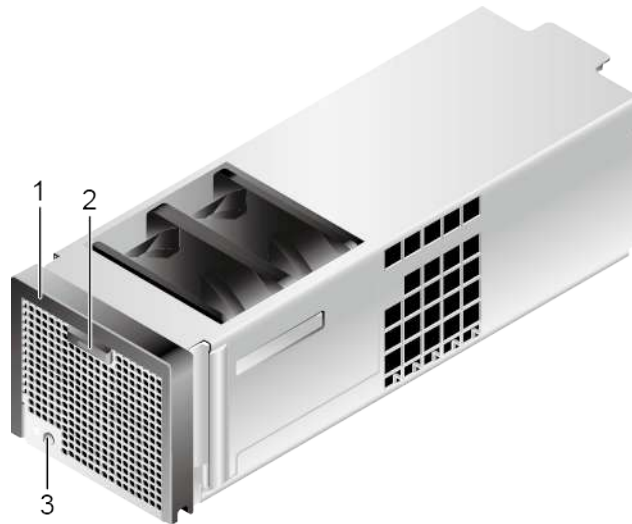

- | | | | |
|---|---|---|------------------|
| 1 | Fan module handle | 2 | Fan module latch |
| 3 | Running/Alarm indicator of the fan module | | |

Indicators

Table 4-18 describes indicators on a fan module of a powered-on storage system.

Table 4-18 Indicators on a fan module

No.	Indicator	Status and Description
3	Running/Alarm indicator of the fan module	<ul style="list-style-type: none"> ¹Steady green: The fan module is working correctly. ¹Steady red: The fan module is faulty. ¹Off: The fan module is powered off.

4.3.2.5 Disk Module

Disk modules provide storage capacity for a storage system to store service data.

Appearance

Figure 4-29 shows the appearance of a disk module.

Figure 4-29 Disk module



- | | | | |
|---|---|---|--------------------------------------|
| 1 | Disk module handle | 2 | Disk module latch |
| 3 | Alarm/Location indicator of the disk module | 4 | Running indicator of the disk module |
| 5 | Disk tray | 6 | Disk |

Indicators

Table 4-19 describes indicators on a disk module of a powered-on storage system.

Table 4-19 Indicators on a disk module

No.	Indicator	Status and Description
3	Alarm/Location indicator of the disk module	1Steady red: The disk module is faulty. 1Blinking red: The disk module is being located. 1Off: The disk module is working correctly or hot swappable.
4	Running indicator of the disk module	1Steady green: The disk module is working correctly. 1Blinking green: Data is being read and written on the disk module. 1Off: The disk module is powered off or

No.	Indicator	Status and Description
		powered on incorrectly.

4.3.3 Indicator Introduction

After a disk enclosure is powered on, you can check the current operating status of the disk enclosure by viewing its indicators.

Indicators on the Front Panel

Figure 4-30 shows the indicators on the front panel of a disk enclosure.

Figure 4-30 Indicators on the front panel of a disk enclosure



- 1 Running indicator of the disk module
- 2 Location/Alarm indicator of the disk module
- 3 Location indicator of the disk enclosure
- 4 Alarm indicator of the disk enclosure
- 5 Power indicator of the disk enclosure

Table 4-20 describes the indicators on the front panel of the disk enclosure.

Table 4-20 Description of the indicators on the front panel of a disk enclosure

Module	No.	Indicator	Status and Description
Disk module	1	Running indicator of the disk module	<ul style="list-style-type: none"> 1 Steady green: The disk module is working correctly. 1 Blinking green: Data is being read and written on the disk module. 1 Off: The disk module is powered off or powered on incorrectly.

Module	No.	Indicator	Status and Description
	2	Alarm/Location indicator of the disk module	1 Steady red: The disk module is faulty. 1 Blinking red: The disk module is being located. 1 Off: The disk module is working correctly or hot swappable.
System enclosure	3	Location indicator of the disk enclosure	1 Blinking blue: The disk enclosure is being located. 1 Off: The disk enclosure is not detected.
	4	Alarm indicator of the disk enclosure	1 Steady red: An alarm is generated in the disk enclosure. 1 Off: The disk enclosure is working correctly.
	5	Power indicator of the disk enclosure	1 Steady green: The disk enclosure is powered on. 1 Off: The disk enclosure is powered off.

Indicators on the Rear Panel

Figure 4-31 shows the indicators on the rear panel of a disk enclosure.

Figure 4-31 Indicators on the rear panel of a disk enclosure

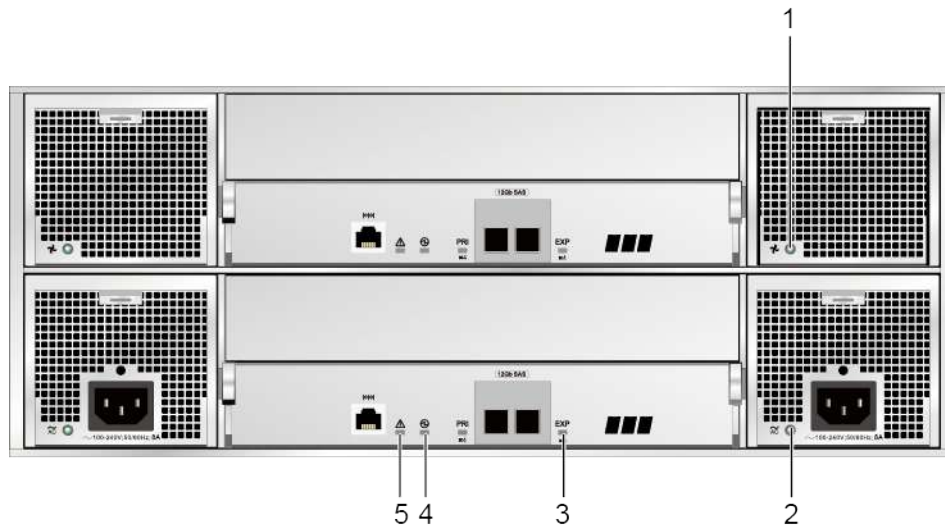

- 1 Running/Alarm indicator of the fan
- 2 Running/Alarm indicator of the power module
- 3 Mini SAS HD expansion port indicator
- 4 Power indicator of the expansion module

5 Alarm indicator of the expansion module

Table 4-21 describes the indicators on the rear panel of the disk enclosure.

Table 4-21 Description of the indicators on the rear panel of a disk enclosure

Module	No.	Indicator	Status and Description
Fan module	1	Running/Alarm indicator of the fan module	<ul style="list-style-type: none"> 1 Steady green: The fan module is working correctly. 11 Steady red: The fan module is faulty. Off: The fan module is powered off.
Power module	2	Running/Alarm indicator of the power module	<ul style="list-style-type: none"> 11 Steady green: The power supply is correct. 11 Blinking green: The power input is normal but the disk enclosure is powered off. Steady red: The power supply is faulty. Off: No external power input is found.
Expansion module	3	Mini SAS HD expansion port indicator	<ul style="list-style-type: none"> 1 Steady blue: The link to the expansion port is normal and the data transfer rate is 4 x 12 Gbit/s. 1 Steady green: The link to the expansion port is normal and the data transfer rate is 4 x 6 Gbit/s or 4 x 3 Gbit/s. 11 Steady red: The port is faulty. Off: The link to the expansion port is down.
	4	Power indicator of the expansion module	<ul style="list-style-type: none"> 1 Steady green: The expansion module is powered on. 1 Off: The expansion module is powered off.
	5	Alarm indicator of the expansion module	<ul style="list-style-type: none"> 1 Steady red: An alarm is generated on the expansion module. 1 Off: The expansion module is working correctly.

4.4 High-Density Disk Enclosure

This chapter describes a high-density disk enclosure in terms of its hardware structure, component functions, front and rear views, and indicators.

4.4.1 Overview

A high-density disk enclosure employs a modular design and consists of a system enclosure, disk modules, fan modules, power modules, and expansion modules.

Overall Structure

Figure 4-32 shows the overall structure of a high-density disk enclosure.

Figure 4-32 Overall structure of a high-density disk enclosure with four 800 W power modules

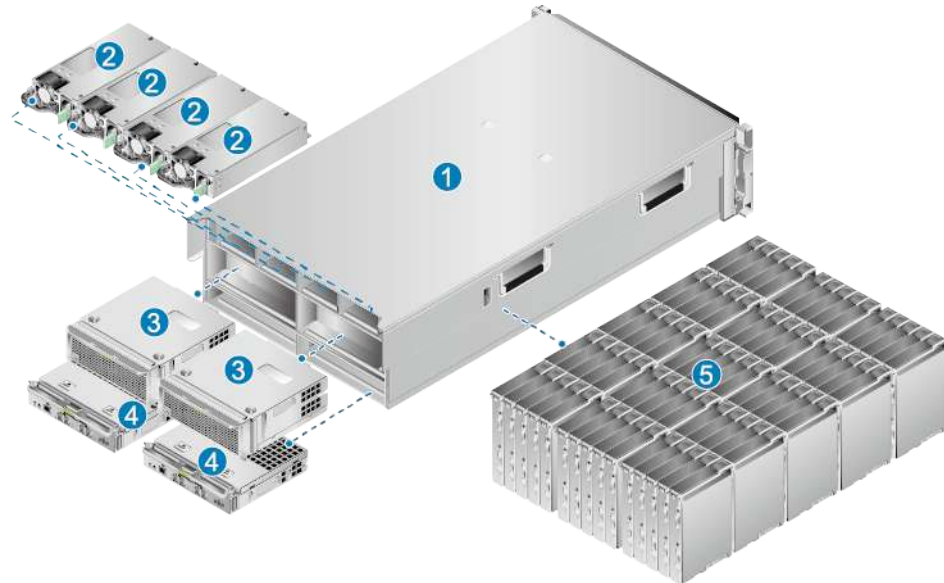

- | | | | |
|---|------------------|---|------------------|
| 1 | System enclosure | 2 | Power module |
| 3 | Fan module | 4 | Expansion module |
| 5 | Disk module | | |

Front View

Figure 4-33 shows the front view of a high-density disk enclosure.

Figure 4-33 Front view of a high-density disk enclosure

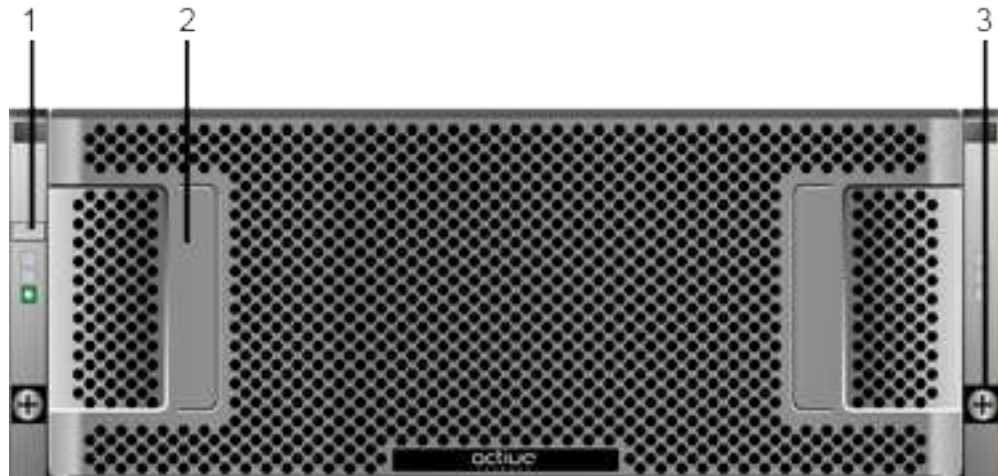

- | | | | |
|---|-----------------------------|---|--------|
| 1 | Disk enclosure ID indicator | 2 | Handle |
| 3 | Captive screw | | |

Rear View

Figure 4-34 shows the rear view of a high-density disk enclosure.

Figure 4-34 Rear view of a high-density disk enclosure

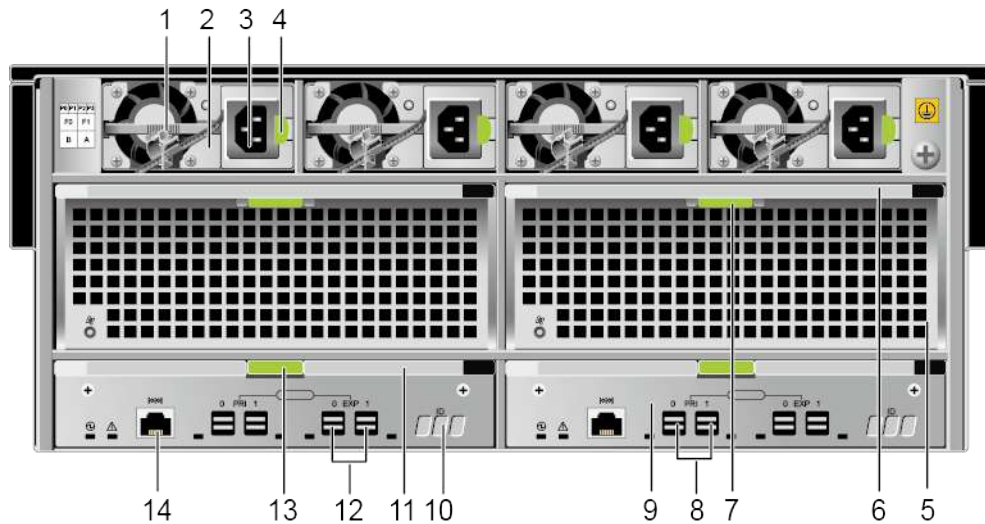

- | | | | |
|---|---------------------|----|--------------------------------|
| 1 | Power module handle | 2 | Power module |
| 3 | Power module socket | 4 | Power module latch |
| 5 | Fan module | 6 | Fan module handle |
| 7 | Fan module latch | 8 | Mini SAS HD expansion port PRI |
| 9 | Expansion module | 10 | Disk enclosure ID indicator |

11	Expansion module handle	12	Mini SAS HD expansion port EXP
13	Expansion module latch	14	Serial port

4.4.2 Component Description

This section provides the illustration and description of each component of the storage system.

4.4.2.1 System Enclosure

The system enclosure integrates a midplane in order to provide reliable connections for interface modules and to distribute power and signals to inner modules.

Appearance

Figure 4-35 shows the appearance of a system enclosure.

Figure 4-35 System enclosure



4.4.2.2 Expansion Module

Each expansion module provides two PRI HD expansion ports and two EXP HD expansion ports. Expansion modules enable a high-density disk enclosure to communicate with a controller enclosure or another high-density disk enclosure.

Appearance

Figure 4-36 shows the appearance of an expansion module.

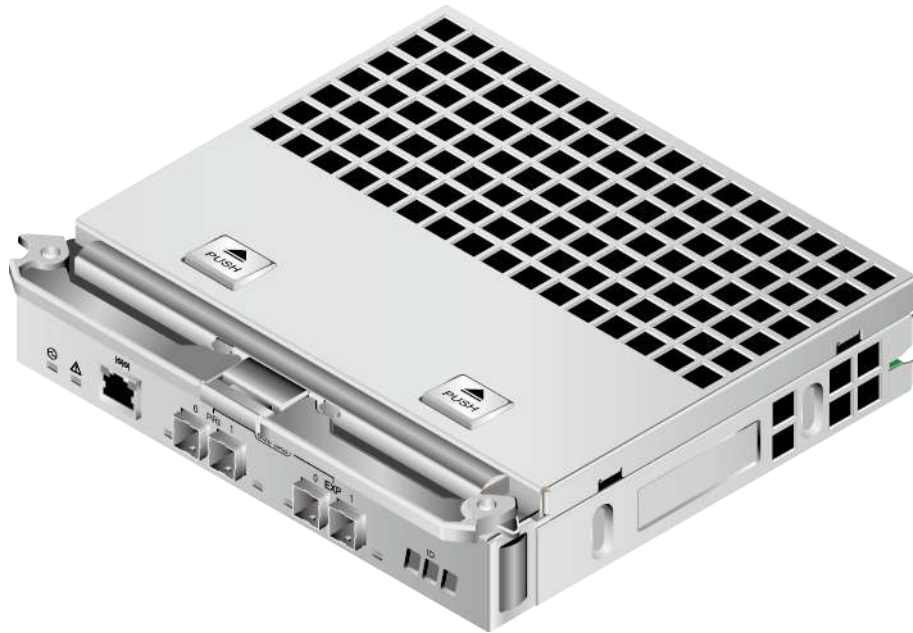
Figure 4-36 Expansion module

Ports

Figure 4-37 shows the ports on an expansion module.

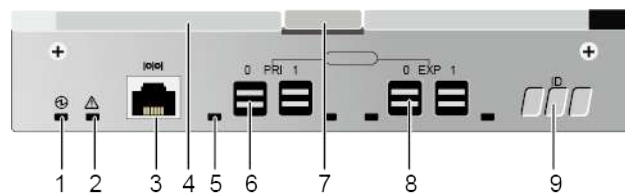
Figure 4-37 Ports on an expansion module

- | | |
|---|---|
| 1 Power indicator of the expansion module | 2 Alarm indicator of the expansion module |
| 3 Serial port | 4 Expansion module handle |
| 5 Mini SAS HD expansion port indicator | 6 Mini SAS HD expansion port PRI |
| 7 Expansion module latch | 8 Mini SAS HD expansion port EXP |
| 9 Disk enclosure ID indicator | |

Indicators

Table 4-22 describes the indicators on an expansion module installed in a disk enclosure of a storage system that is powered on.

Table 4-22 Indicators on an expansion module in a disk enclosure

No.	Indicator	Status and Description
1	Power indicator of the expansion module	¹ Steady green: The expansion module is working correctly. ¹ Off: The expansion module is powered off.
2	Alarm indicator of the expansion module	¹ Steady red: An alarm about the expansion module is generated. ¹ Off: The expansion module is powered off or working correctly.
5	Mini SAS HD expansion port indicator	¹ Steady blue: The link to the expansion port is normal, and the data transfer rate is 4 x 6 Gbit/s. ¹ Steady green: The link to the expansion port is normal, and the data transfer rate is 4 x 3 Gbit/s. ¹ Steady red: The port is faulty. ¹ Off: The link to the expansion port is down.

4.4.2.3 Disk Module

Disk modules provide storage capacity for a storage system to store service data.

Appearance

Figure 4-38 shows the appearance of a disk module.

Figure 4-38 Disk module

- | | | | |
|---|------------------------------|---|-------------------|
| 1 | Disk tray | 2 | Disk |
| 3 | Disk module handle | 4 | Disk module latch |
| 5 | Disk module status indicator | | |

Indicator

Table 4-23 describes the indicator on a disk module of a storage system that is powered on.

Table 4-23 Indicator on a disk module

No.	Indicator	Status and Description
5	Disk module status indicator	<ul style="list-style-type: none"> 1Steady green: The disk module is working correctly. 1Steady red: The disk module is faulty. 1Blinking blue: The disk module is located. 1Blinking red: The disk module is about to fail. 1Off: The disk module is powered off.

4.4.2.4 Power Module

The storage system supports AC power modules. Allowing a high-density disk enclosure to work at the maximum power consumption.

Appearance

Figure 4-39 shows the appearance of a power module.

Figure 4-39 AC power module

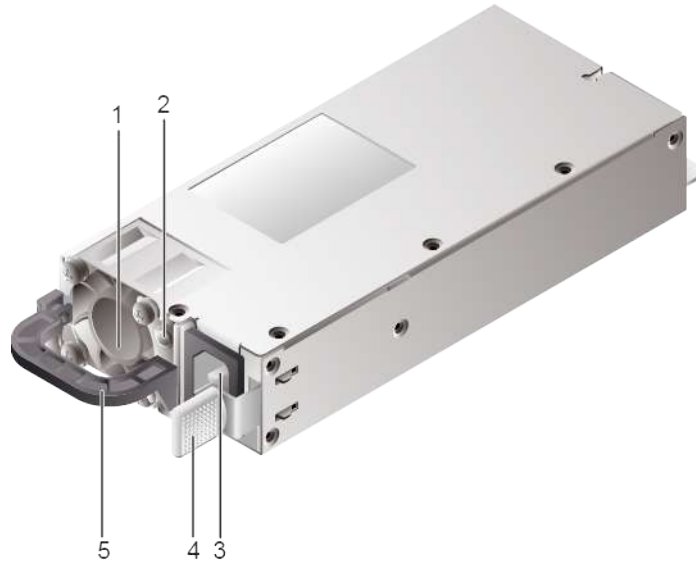

- | | | | |
|---|---------------------|---|---|
| 1 | Power module fan | 2 | Running/Alarm indicator of the power module |
| 3 | Power module socket | 4 | Power module latch |
| 5 | Power module handle | | |

Indicator

Table 4-24 describes the indicator on a power module of a storage system that is powered on.

Table 4-24 Indicator on a power module

No.	Indicator	Status and Description
2	Running/Alarm indicator of the power module	¹ Steady green: The power supply is correct. ¹ Blinking green: The power input is normal but the disk enclosure is powered off. ¹ Steady red: The power supply is faulty. ¹ Off: No external power input is found.

4.4.2.5 Fan Module

A fan module provides heat dissipation and supports the normal running of the disk enclosure in maximum power consumption mode.

Appearance

Figure 4-40 shows the appearance of a fan module.

Figure 4-40 Fan module

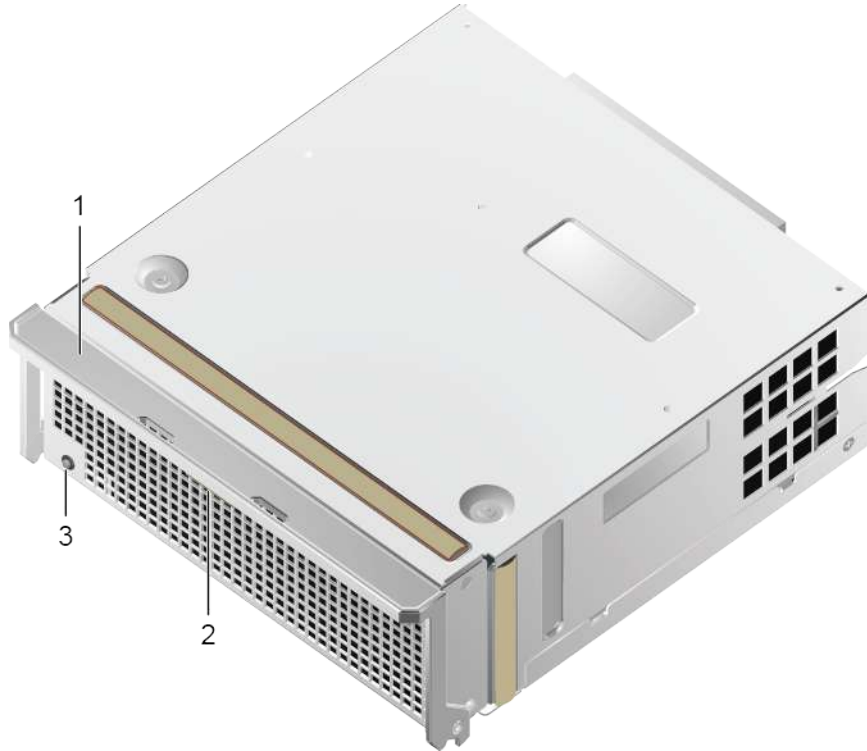

- 1 Fan module handle
- 2 Fan module latch
- 3 Fan module running/alarm indicator

Indicator

Table 4-25 describes the indicator on a fan module of a storage system that is powered-on.

Table 4-25 Indicator on a fan module

No.	Indicator	Status and Description
3	Fan module running/alarm indicator	<ul style="list-style-type: none"> !Steady green: The fan module is working correctly. !Steady red: The fan module is faulty. !Off: The fan module is powered off.

4.4.3 Indicator Introduction

After a disk enclosure is powered on, you can check the current operating status of the disk enclosure by viewing its indicators.

Indicators on the Front Panel

Figure 4-41 shows the indicators on the front panel of a high-density disk enclosure.

Figure 4-41 Indicators on the front panel of a high-density disk enclosure



- | | | | |
|---|---|---|---|
| 1 | High-density disk enclosure Location indicator | 2 | High-density disk enclosure overtemperature Alarm indicator |
| 3 | High-density disk enclosure internal module Alarm indicator | 4 | High-density disk enclosure rear module Alarm indicator |
| 5 | High-density disk enclosure Power indicator | 6 | High-density disk enclosure Alarm indicator |

Table 4-26 describes the indicators on the front panel of a high-density disk enclosure.

Table 4-26 Description of the indicators on the front panel of a high-density disk enclosure

Module	No.	Indicator	Status and Description
System enclosure	1	High-density disk enclosure Location indicator	¹ Blinking blue: The high-density disk enclosure has been located. ¹ Off: The high-density disk enclosure is not located.
	2	High-density disk enclosure overtemperature Alarm indicator	¹ Steady red: The temperature of the high-density disk enclosure is too high. ¹ Off: The temperature of the high-density disk enclosure is within the normal range.
	3	High-density disk enclosure internal module Alarm indicator	¹ Steady red: Internal disk modules of the high-density disk enclosure are faulty. ¹ Blinking red: Internal disk modules of the high-density disk enclosure is about to fail. ¹ Off: Internal disk modules are running correctly.
	4	High-density disk enclosure rear	¹ Steady red: The number of rear field replaceable units (FRUs) is fewer than half

Module	No.	Indicator	Status and Description
		module Alarm indicator	of that in standard configuration or rear FRUs are faulty. NOTE Modules on the rear of the high-density disk enclosure include power modules, fan modules, and expansion modules. 1Off: Rear FRUs are running correctly.
	5	High-density disk enclosure Power indicator	1Steady green: The high-density disk enclosure is powered on. 1Off: The high-density disk enclosure is not powered on.
	6	High-density disk enclosure Alarm indicator	1Steady red: An alarm is generated in the high-density disk enclosure. 1Off: The high-density disk enclosure is running correctly.

Indicators on the Rear Panel

Figure 4-42 shows the indicators on the rear panel of a high-density disk enclosure.

Figure 4-42 Indicators on the rear panel of a high-density disk enclosure

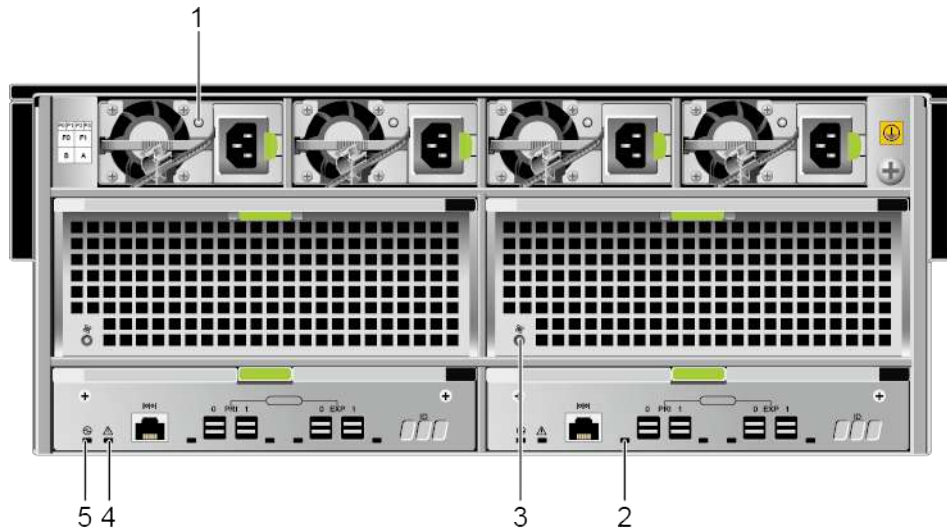

- 1 Running/Alarm indicator of the power module
- 2 Indicator of a mini SAS HD expansion port
- 3 Fan module Running/Alarm indicator
- 4 Expansion module Alarm indicator
- 5 Expansion module Power indicator

Table 4-27 describes the indicators on the rear panel of a high-density disk enclosure.

Table 4-27 Description of the indicators on the front panel of a high-density disk enclosure

Module	No.	Indicator	Status and Description
Power module	1	Running/Alarm indicator of the power module	<p>¹ Steady green: The power supply is correct.</p> <p>¹ Blinking green: The power input is normal but the disk enclosure is powered off.</p> <p>¹ Steady red: The power supply is faulty.</p> <p>¹ Off: No external power input is found.</p>
Expansion module	2	Indicator of a mini SAS HD expansion port	<p>¹ Steady blue: The link is up and the data transfer rate is 4 x 6 Gbit/s.</p> <p>¹ Steady green: The link is up and the data transfer rate is 4 x 3 Gbit/s.</p> <p>¹ Steady red: The expansion port is faulty.</p> <p>¹ Off: The link is down.</p>
Fan module	3	Fan module Running/Alarm indicator	<p>¹ Steady green: The fan module is running correctly.</p> <p>¹ Steady red: The fan module is faulty.</p> <p>¹ Off: The fan module is not powered on.</p>
Expansion module	4	Expansion module Alarm indicator	<p>¹ Steady red: The expansion module is faulty.</p> <p>¹ Off: The expansion module is not powered or is running correctly.</p>
	5	Expansion module Power indicator	<p>¹ Steady green: The expansion module is running correctly.</p> <p>¹ Off: The expansion module is not powered on.</p>

4.5 Device Cables

Device cables used in the storage system include power cables, ground cables, and signal cables. This chapter displays the views and describes the functions and specifications of various cables.

4.5.1 Power Cables

Power cables are classified into AC power cables and PDU power cables. Power cables supply power to devices in a cabinet. One end of a power cable is connected to the power socket of the storage system, and the other end to an external power supply.

Appearance

- 1 Each AC power module is equipped with one AC power cable. Power cables supply power to devices in a cabinet. One end of a power cable is connected to the power socket of a device, and the other end to an external power supply. Figure 4-43 shows the appearance of an AC power cable.

Figure 4-43 AC power cable



- 1 If a cabinet is equipped with power distribution units (PDUs), use PDU power cables to supply power to devices in the cabinet. Figure 4-44 shows the appearance of a PDU power cable.

Figure 4-44 PDU power cable



4.5.2 Ground Cables

Ground cables are used for device grounding to improve the security when you perform operations on a storage device.

Appearance

- Figure 4-45 shows the appearance of a ground cable.

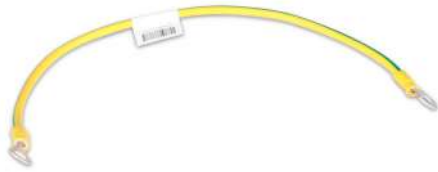
Figure 4-45 Ground cable

4.5.3 Network Cables

The storage system uses network cables for its management network ports, service network ports, and other ports to connect to other devices or servers for communication.

Appearance

The storage system communicates with the external network using network cables. One end of the network cable connects to the management network port, service network port, or other maintenance network port of the storage system, and the other end connects to the network switch, application server or others.

Figure 4-46 shows the appearance of a network cable.

**NOTE**

GE electrical ports employ CAT5 network cables or CAT6A shielded network cables. 10GE electrical ports employ 1 m to 3 m CAT6A shielded network cables.

Figure 4-46 Network cable

4.5.4 Serial Cables

Serial cables are used to connect the serial ports of the storage system to other devices.

Appearance

A serial cable connects the serial port of the storage system to the port of the maintenance terminal.

One end of a serial cable is the RJ-45 port used to connect to the serial port of a storage system. The other end is a DB-9 port used to connect to the port of the maintenance terminal.

Figure 4-47 shows the appearance of a serial cable.

Figure 4-47 Serial cable

4.5.5 Mini SAS HD Cables

Mini SAS HD cables are used to connect expansion ports. Mini SAS HD cables are divided into mini SAS HD electrical cables and mini SAS HD optical cables.

4.5.5.1 Mini SAS HD Electrical Cables

Mini SAS HD electrical cables are used to connect a controller enclosure to a disk enclosure or connect two disk enclosures.

Figure 4-48 shows the appearance of a mini SAS HD electrical cable.

Figure 4-48 mini SAS HD electrical cable

4.5.5.2 Mini SAS HD optical cables

Mini SAS HD optical cables are used to connect a controller enclosure to a disk enclosure or connect two disk enclosures.

Figure 4-49 shows the appearance of a mini SAS HD optical cable.

Figure 4-49 mini SAS HD optical cable**NOTE**

The optical connector of a mini SAS HD optical cable has an O/E conversion module built in and provides electrical ports.

4.5.6 Optical Fibers

The storage system communicates with Fibre Channel switches through optical fibers. One end of the optical fiber connects to the Fibre Channel host bus adapter (HBA), and the other end connects to the Fibre Channel switch or the application server. The two ends of the optical fiber are LC connectors.

Figure 4-50 shows the appearance of an 8 Gbit/s or 16 Gbit/s optical fiber.

**NOTE**

When connecting cables, select proper cables according to site requirements and label information.

Figure 4-50 Optical Fiber

4.5.7 FDR Cables

FDR (Fourteen Data Rate) are used for 56 Gbit/s IB interface module.

Figure 4-51 shows the appearance of an FDR cable.

Figure 4-51 FDR cable

4.5.8 MPO-4*DLC Fiber

MPO-4*DLC fiber is used for high-density 8 Gbit/s Fiber Channel interface module.

Figure 4-52 shows the appearance of the MPO-4*DLC fiber.

Figure 4-52 MPO-4*DLC fiber



5 Product Specifications

About This Chapter

This chapter describes the hardware specifications and software specifications of the mRAID16 storage system.

5.1 Hardware Specifications

Hardware specifications cover the hardware configuration, port specifications, disk specifications, dimensions, weight, electrical specifications, and reliability specifications.

5.2 Software Specifications

The software specifications include the basic specifications, feature specifications, performance specifications, supported operating systems, and license control.

5.1 Hardware Specifications

Hardware specifications cover the hardware configuration, port specifications, disk specifications, dimensions, weight, electrical specifications, and reliability specifications.

Table 5-1 describes the hardware specification categories to help you quickly find out the specification information you need.

Table 5-1 Description of hardware specification categories

Category	Description
Hardware configuration	Describes the configuration of major hardware components, such as processors, memory capacity, hard disks, and ports.
Port specifications	Describes the port specifications, such as the maximum number of ports provided by each type of interface module and the maximum number of interface modules supported by each controller.
Disk specifications	Describes the dimensions, rotational speed, capacity, and weight of each type of disk.
Dimensions and weight	Describes the dimensions and weight of controller enclosures and disk enclosures.

Category	Description
Electrical specifications	Describes the electrical specifications of controller enclosures and disk enclosures.
Reliability specifications	Describes the reliability specifications of the mRAID16 storage system storage systems.

Hardware Configuration

Item	Description
Processors per controller	1 x 6-core processor
Cache size per controller	¹ 24 GB ¹ 48 GB ¹ 64 GB
Maximum number of controllers per enclosure	2
Maximum number of disks	750
Controller enclosure configuration	2 U controller enclosure with twelve 3.5-inch disks
Maximum number of disk enclosures	31
Maximum number of hot-swappable interface modules	4
Redundancy of main components	¹ BBUs: 1+1 ¹ Power modules: 1+1 Fans: 3+1

Port Specifications

Port Specifications	Description
4-port 8 Gbit/s FC interface module	Four ports for each front-end module
8-port 8 Gbit/s FC interface module	Eight ports for each front-end module
16 Gbit/s Fibre Channel interface module	Two ports for each front-end module
GE electrical interface	Four ports for each front-end module

Port Specifications	Description
module	
10 GE electrical interface module	Four ports for each front-end module
10 Gbit/s TOE interface module	Four ports for each front-end module
2-port 10 Gbit/s FCoE interface module	Two ports for each front-end module
4-port 10 Gbit/s FCoE interface module	Four ports for each front-end module
12 Gbit/s SAS expansion module	Four ports for each back-end module
56 Gbit/s (4 x 14 Gbit/s) IB interface module	Two ports for each front-end module
SmartIO interface module	Four ports for each front-end or nodes-interconnection module

Max. Number of Ports Per Controller	Description
8 Gbit/s Fibre Channel port	12
16 Gbit/s Fibre Channel port	12
GE port	8
10GE port	8
10 Gbit/s TOE port	8
10 Gbit/s FCoE port (VN2VN)	4
12 Gbit/s SAS expansion port	6
56 Gbit/s (4 x 14 Gbit/s) IB port	4

Disk Specifications

Disk Type ^a	Dimensions	Rotational Speed	Weight	Capacity

Disk Type ^a	Dimensions	Rotational Speed	Weight	Capacity
NL-SAS	3.5-inch	7200 rpm	0.72 kg (1.59 lb)	12 TB ^c 13 TB 14 TB ^d 16 TB ^d 18 TB
SSD	3.5-inch	-	0.38 kg (0.84 lb)	1400 GB eMLC 1600 GB eMLC 1900 GB eMLC 11.8 TB eMLC
<p>a: Restricted by the storage principles, SSDs and mechanical disks such as NL-SAS and SAS disks cannot be preserved for a long term while they are powered off.</p> <p>¹SSDs where no data is stored can be preserved for a maximum of 12 months while they are powered off. SSDs where data has been stored can be preserved for a maximum of 3 months while they are powered off. If the maximum preservation time is exceeded, data loss or SSD failure may occur.</p> <p>¹Packed mechanical disks can be preserved for a maximum of six months. Unpacked mechanical disks that are powered off can be preserved for a maximum of six months too. If the maximum preservation time is exceeded, data loss or disk failure may occur. The maximum preservation time is determined based on the disk preservation specifications provided by the mechanical disk vendor. For details about the specifications, see the manual provided by the vendor.</p> <p>b: Self-encrypting disk supported</p> <p>c: High-density disk enclosure supported</p> <p>d: Self-encrypting disk and high-density disk enclosure supported</p>				

Dimensions and Weight (unpackaged)

Module	Parameter	Description
Controller enclosure	Dimensions	¹¹ Depth: 748 mm (29.45 in.) Width: 447 mm (17.60 in.) Height: 86.1 mm (3.39 in.)
	Weight (without disks)	30 kg (66.15 lb)
2 U SAS disk enclosure	Dimensions	¹¹ Depth: 488 mm (19.21 in.) ¹ Width: 447 mm (17.60 in.) Height: 86.1 mm (3.39 in.)
	Weight (without disks)	13.3 kg (29.32 lb)
4 U SAS	Dimensions	¹ Depth: 448 mm (17.64 in.)

Module	Parameter	Description
disk enclosure		¹ Width: 447 mm (17.60 in.) ¹ Height: 175 mm (6.89 in.)
	Weight (without disks)	26.5 kg (58.42 lb)
4 U high-density disk enclosure	Dimensions	Without cable management assembly: ¹ Depth: 790 mm (31.1 in.) ¹ Width: 446 mm (17.56 in.) ¹ Height: 176.5 mm (6.95 in.) With cable management assembly: ¹ Depth: 974 mm (38.4 in.) ¹ Width: 446 mm (17.56 in.) ¹ Height: 176.5 mm (6.95 in.)
	Weight (without disks)	40.8 kg (89.95 lb)

Electrical Specifications

Item	Description	
Power consumption	Controller enclosure	¹¹ Max: 718 W ¹ Typical: 553 W Min: 396 W
	4 U disk enclosure	¹¹ Max: 459 W ¹ Typical: 283 W Min: 207 W
	4 U high-density disk enclosure	¹ Max: 932 W ¹ Typical: 815 W ¹ Min: 742 W
Power voltage and rated currency	Controller enclosure	AC: • 100 V to 240 V, $\pm 10\%$, 10 A to 6 A, single-phase, 50/60Hz ¹ Supports dual-live-line input (2W+PE), 200 V to 240 V, $\pm 10\%$ High voltage DC (N/A for North America and Canada) : 240 V, $\pm 20\%$, 6.5 A DC: -48 V to -60 V, $\pm 20\%$, 30 A
	Disk enclosure	AC: • 100 V to 240 V, $\pm 10\%$, 8 A, single-phase, 50/60Hz

Item		Description
		High voltage DC (N/A for North America and Canada) : <ul style="list-style-type: none"> • 240 V, $\pm 20\%$, 3.5 A DC: <ul style="list-style-type: none"> • -48 V to -60 V, $\pm 20\%$, 18.5 A
	High-density disk enclosure	AC: <ul style="list-style-type: none"> • 100 V to 127 V, $\pm 10\%$, 10 A, single-phase, 50/60Hz • 200 V to 240 V, $\pm 10\%$, 5 A, single-phase, 50/60Hz
	AC power input type (socket type)	¹ AC: IEC60320-C14 ¹ High voltage DC: IEC60320-C14 ¹ DC: OT-M6
Each BBU capacity / Overall discharge time		18 Wh / 250 seconds

5.2 Software Specifications

The software specifications include the basic specifications, feature specifications, performance specifications, supported operating systems, and license control.

Table 5-2 describes the categories of the storage unit software specification to help you quickly find out the specification information you need.

Table 5-2 Description of software specification categories

Category	Description
Basic specifications	Describes the basic software specifications of the storage unit, including the maximum number of connected application servers, maximum number of LUNs, and maximum number of mapping views.
Feature specifications	Describes the feature specifications of the storage unit, such as snapshot, remote replication, and LUN copy.
Supported operating systems	Describes the operating systems supported by the storage unit.
License control	Describes whether software features of the storage unit are controlled by licenses.

Basic Specifications

Item	Description
Maximum number of application server	¹ Fibre Channel and InfiniBand ports: 4096 ¹ iSCSI ports: 256

Item	Description
connections	
Maximum number of LUNs	8192
Maximum number of LUN groups	4096
Maximum number of PE LUNs	64
Maximum number of mapping views	4096
Maximum number of disk domains	64
Maximum number of disks in a disk domain	750
Minimum number of disks in a disk domain	4
Maximum number of storage pools	64
Maximum of LUNs in a storage pool	4096
Minimum capacity of a LUN	512 KB
Maximum capacity of a LUN	256 TB

Performance Specifications

Item (For block service)	Description
Maximum IOPS (full cache read hit)	1,000,000
Maximum bandwidth (MB/s)	8,000

Supported Operating Systems

Only the common operating systems supported by the storage systems are listed. For details, contact Active Storage technical support engineers.

Operating System	Description
Windows operating	Mainstream Windows operating systems are supported, including

Operating System	Description
system	but not limited to the following: †Windows Server 2003 R2 Standard SP2 †Windows Server 2003 R2 Datacenter SP2 †Windows Server 2003 R2 Enterprise Edition SP2 †Windows Server 2008 R2 Standard SP1 †Windows Server 2008 R2 Datacenter SP1 †Windows Server 2008 R2 Enterprise Edition SP1 †Windows Server 2012 Standard †Windows Server 2012 Datacenter †Windows Server 2012 Essentials †Windows Server 2012 Foundation X64 Edition
Linux operating system	Mainstream Linux operating systems are supported, including but not limited to the following: †SUSE Linux Enterprise Server 10 †SUSE Linux Enterprise Server 11 †RedHat Enterprise Server AS 5 †RedHat Enterprise Server AS 6
Other mainstream operating systems	†HP-UX 11i v2 †HP-UX 11i v3 †AIX 6.1 †AIX 7.1 †Solaris 10 for Sparc †Solaris 11 for Sparc †VMware ESXi 4.1 †VMware ESXi 5.0 †Citrix XenServer 5.6 †Citrix XenServer 6.0 †MAC OS X 10.X †MAC OS X 11.X †Other mainstream operating systems

6 Environmental Requirements

About This Chapter

Environmental requirements cover the following aspects: temperature, humidity, particle contaminants, corrosive airborne contaminants, heat dissipation, and noise.

6.1 Temperature, Humidity, and Altitude

Temperature, humidity, and altitude requirements must be met so that storage systems can correctly work or be properly preserved.

6.2 Particle Contaminants

Particle contaminants and other negative environmental factors (such as abnormal temperature and humidity) may expose IT equipment to a higher risks of corrosive failure. This clause specifies the limitation on particle contaminants with the aim at avoiding such risks.

6.3 Corrosive Airborne Contaminants

Corrosive airborne contaminants and other negative environmental factors (such as abnormal temperature and humidity) may expose IT equipment to higher risks of corrosive failure. This article specifies the limitation on corrosive airborne contaminants with an aim at avoiding such risks.

6.4 Heat Dissipation and Noise

A storage system can run steadily using the heat dissipation system carried in its own fan modules. An external device is necessary to remove the hot air discharged from a storage system into the equipment room to ensure proper air circulation.

6.1 Temperature, Humidity, and Altitude

Temperature, humidity, and altitude requirements must be met so that storage systems can correctly work or be properly preserved.

Table 6-1 lists the temperature, humidity, and altitude requirements of the storage systems.

Table 6-1 Temperature, humidity, and altitude requirements of the storage systems

Parameter	Condition	Requirement
Temperature	Operating temperature	<ul style="list-style-type: none"> 5°C to 40°C (41°F to 104°F) when the altitude is between -60 m and +1800 m (-196.85 ft. and +5905.51 ft.) ¹At altitudes between 1800 m and 3000 m (5905.51 ft. and 9842.52 ft.), the

Parameter	Condition	Requirement
		temperature drops by 1°C (1.8°F) for 220 m (721.78 ft.) of altitude increase.
	Storage temperature	-40°C to +70°C (-40°F to +158°F)
Humidity	Operating humidity	10% RH ^a to 90% RH
	Non-operating humidity	5% RH to 95% RH
	Storage humidity	5% RH to 95% RH
Altitude	Operating altitude of disks	<ul style="list-style-type: none"> 1 HDDs: -304.8 m to +3048 m (-999.99 ft. to +9999.99 ft.) 1 SSDs: -305 m to +3048 m (-1000.64 ft. to +9999.99 ft.)
	Non-operating altitude of disks	<ul style="list-style-type: none"> 1 HDDs: -305 m to +12192 m (-1000.64 ft. to +39999.51 ft.) 1 SSDs: -305 m to +12192 m (-1000.64 ft. to +39999.51 ft.)
a: RH, Relative Humidity		

6.2 Particle Contaminants

Particle contaminants and other negative environmental factors (such as abnormal temperature and humidity) may expose IT equipment to a higher risks of corrosive failure. This clause specifies the limitation on particle contaminants with the aim at avoiding such risks.

The concentration level of particle contaminants in a data center should meet the requirements listed in the white paper entitled *Gaseous and Particulate Contamination Guidelines for Data Centers published in 2011* by American Society of Heating Refrigerating and Air-conditioning Engineers (ASHRAE) Technical Committee (TC) 9.9.

ASHRAE, affiliated to International Organization for Standardization (ISO), is an international organization operated for the exclusive purpose of advancing the arts and sciences of heating, ventilation, air-conditioning, and refrigeration (HVAC & R). The *Gaseous and Particulate Contamination Guidelines for Data Centers* is widely accepted, which is prepared by the members of ASHRAE TC 9.9, AMD, Cisco, Cray, Dell, EMC, Hitachi, HP, IBM, Intel, Seagate, SGI, and Sun.

According to the Guidelines, particle contaminants in a data center shall reach the cleanliness of ISO 14664-1 Class 8:

- Each cubic meter contains not more than 3,520,000 particles that are equal to or greater than 0.5 µm.
- Each cubic meter contains not more than 832,000 particles that are equal to or greater than 1 µm.

- Each cubic meter contains not more than 29,300 particles that are equal to or greater than 5 μm .

It is recommended that you use an effective filter to process air flowing into the data center as well as a filtering system to periodically clean the air already in the data center.

ISO 14644-1, Cleanrooms and Associated Controlled Environments - Part 1: Classification of Air Cleanliness, is the primary global standard on air cleanliness classification. Table 6-2 gives the air cleanliness classification by particle concentration.

Table 6-2 Air cleanliness classification by particle concentration of ISO 14664-1

ISO Class	Maximum allowable concentrations (particles/m ³) for particles equal to and greater than the considered sizes shown below					
	$\geq 0.1 \mu\text{m}$	$\geq 0.2 \mu\text{m}$	$\geq 0.3 \mu\text{m}$	$\geq 0.5 \mu\text{m}$	$\geq 1 \mu\text{m}$	$\geq 5 \mu\text{m}$
Class 1	10	2	-	-	-	-
Class 2	100	24	10	4	-	-
Class 3	1000	237	102	35	8	-
Class 4	10,000	2,370	1,020	352	83	-
Class 5	100,000	23,700	10,200	3,520	832	29
Class 6	1,000,000	237,000	102,000	35,200	8,320	293
Class 7	-	-	-	352,000	83,200	2,930
Class 8	-	-	-	3,520,000	832,000	29,300
Class 9	-	-	-	-	8,320,000	293,000

6.3 Corrosive Airborne Contaminants

Corrosive airborne contaminants and other negative environmental factors (such as abnormal temperature and humidity) may expose IT equipment to higher risks of corrosive failure. This article specifies the limitation on corrosive airborne contaminants with an aim at avoiding such risks.

Table 6-3 lists common corrosive airborne contaminants and their sources.

Table 6-3 Common corrosive airborne contaminants and their sources

Symbol	Sources
H ₂ S	Geothermal emissions, microbiological activities, fossil fuel processing, wood rot, sewage treatment
SO ₂ , SO ₃	Coal combustion, petroleum products, automobile emissions, ore smelting, sulfuric acid manufacture
S	Foundries, sulfur manufacture, volcanoes

Symbol	Sources
HF	Fertilizer manufacture, aluminum manufacture, ceramics manufacture, steel manufacture, electronics device manufacture
NO _x	Automobile emissions, fossil fuel combustion, chemical industry
NH ₃	Microbiological activities, sewage, fertilizer manufacture, geothermal emissions, refrigeration equipment
C	Incomplete combustion (aerosol constituent), foundry
CO	Combustion, automobile emissions, microbiological activities, tree rot
Cl ₂ , ClO ₂	Chlorine manufacture, aluminum manufacture, zinc manufacture, refuse decomposition
HCl	Automobile emissions, combustion, forest fire, oceanic processes, polymer combustion
HBr, HI	Automobile emissions
O ₃	Atmospheric photochemical processes mainly involving nitrogen oxides and oxygenated hydrocarbons
C _N H _N	Automobile emissions, animal waste, sewage, tree rot

The concentration level of corrosive airborne contaminants in a data center should meet the requirements listed in the white paper entitled *Gaseous and Particulate Contamination Guidelines for Data Centers published in 2011* by the American Society of Heating Refrigerating and Air-conditioning Engineers (ASHRAE) Technical Committee (TC) 9.9.

According to the Guidelines, corrosive airborne contaminants in a data center should meet the following requirements:

1 Copper corrosion rate

Less than 300 Å/month per ANSI/ISA-71.04-1985 severity level G1.

- Silver corrosion rate

Less than 200 Å/month.



NOTE

Å is a unit of length. One Å is equal to 1/10,000,000,000 meter.

According to ANSI/ISA-71.04-1985 Environmental Conditions for Process Measurement and Control Systems: Airborne Contaminants, the gaseous corrosivity levels are G1 (mild), G2 (moderate), G3 (harsh), and GX (severe), as described in Table 6-4.

Table 6-4 Gaseous corrosivity levels per ANSI/ISA-71.04-1985

Severity Level	Copper Reactivity Level	Description
G1 (mild)	300 Å/month	An environment sufficiently well-controlled

Severity Level	Copper Reactivity Level	Description
		such that corrosion is not a factor in determining equipment reliability.
G2 (moderate)	300 Å/month to 1000 Å/month	An environment in which the effects of corrosion are measurable and may be a factor in determining equipment reliability.
G3 (Harsh)	1000 Å/month to 2000 Å/month	An environment in which there is high probability that corrosion will occur.
GX (severe)	> 2000 Å/month	An environment in which only specially designed and packaged equipment would be expected to survive.

See Table 6-5 for the copper and silver corrosion rate requirements.

Table 6-5 Concentration limitation of corrosive airborne contaminants in a data center

Group	Gas	Unit	Concentration
Group A	H ₂ S	ppb ^a	< 3
	SO ₂	ppb	< 10
	Cl ₂	ppb	< 1
	NO ₂	ppb	< 50
Group B	HF	ppb	< 1
	NH ₃	ppb	< 500
	O ₃	ppb	< 2
a: Parts per billion (ppb) is the number of units of mass of a contaminant per 1000 million units of total mass.			

Group A and group B are common gas groups in a data center. The concentration limits of Group A or group B that correspond to copper reactivity level G1 are calculated based on the premise that relative humidity in the data center is lower than 50% and that the gases in the group interact with each other. A 10% of increase in the relative humidity will heighten the gaseous corrosivity level by 1.

Corrosion is not determined by a single factor, but by comprehensive environmental factors such as temperature, relative humidity, corrosive airborne contaminants, and ventilation. Any of the environmental factors may affect the gaseous corrosivity level. Therefore, the concentration limitation values specified in the previous table are for reference only.

6.4 Heat Dissipation and Noise

A storage system can run steadily using the heat dissipation system carried in its own fan modules. An external device is necessary to remove the hot air discharged from a storage system into the equipment room to ensure proper air circulation.

Heat Dissipation

Traditional heat dissipation modes are as follows:

1 Air goes into a controller enclosure from the front end and out of its back end.

Cooling air enters through small holes on the interface modules. After dissipating the heat of interface modules, controllers, and power modules, the air is discharged by fans. The controller enclosure dynamically adjusts rotational speed of the fans based on the operational temperature of the storage system.

1 Air goes into a disk enclosure from the front end and out of its back end.

Cooling air enters through the space between disks, passing the midplane, into the power modules and expansion modules. After dissipating the heat, the air is discharged by fans. The disk enclosure dynamically adjusts rotational speed of the fans based on the operational temperature of the storage system.

For better maintenance, ventilation, and heat dissipation, pay attention to the following when installing the storage system in the cabinet:

1 To ensure smooth ventilation, the cabinet should be at least 100 cm (39.4 inches) away from the equipment room walls and at least 120 cm (47.24 inches) away from other cabinets (that are in front of or behind).

1 To keep air convection between the cabinet and the equipment room, no enclosed space is allowed in the cabinet. 1 U (44.45 mm, 1.75 inches) space should be left above and below each device.

The airflow parameters of the storage system are shown in Table 6-6.

Table 6-6 Airflow parameters of the storage system

System airflow					
Controller enclosure	1	192 CFM ^a (at max. fan speed)			
	1	68 CFM (25°C)			
2 U disk enclosure	1	117 CFM (at max. fan speed)			
	1	38 CFM (25°C)			
4 U disk enclosure	1	151 CFM (at max. fan speed)			
	1	52 CFM (25°C)			
4 U high-density disk enclosure	1	210 CFM (at max. fan speed)			
	1	116 CFM (25°C)			
a: CFM, Cubic Feet per Minute					

The heat dissipation parameters of the storage system are shown in Table 6-7.

Table 6-7 Heat dissipation parameters of the storage system

Maximum heat dissipation	Description
Controller enclosure	2448 BTU/h
2 U disk enclosure	1194 BTU/h
4 U disk enclosure	1565 BTU/h
4 U high-density disk enclosure	3178 BTU/h
a: BTU, British Thermal Unit.	

Noise

The disks and fans make noise when in operation, with fans being the major noise source. The intensity of fan rotation is associated with the temperature. A higher temperature leads to greater rotational speed by the fans, which in return creates greater noise. Therefore, there is a direct correlation between the noise made by a storage system and the ambient temperature in the equipment room.

When the temperature is 25°C, the parameters of the noise generated by the storage system are shown in Table 6-8.

Table 6-8 Noise parameters of the storage system

Device	Noise power
2 U controller enclosure	65.1 dB
3 U controller enclosure	69.4 dB
6 U controller enclosure	71.0 dB
2 U disk enclosure	67.5 dB
4 U disk enclosure	66.3 dB
4 U high-density disk enclosure	75.4 dB

7 Standard Compliance

The chapter describes the protocol standards, the safety specifications and electromagnetic compatibility (EMC) standards, the industry standards that the storage system complies with.

Protocol Standards

Table 7-1 lists the protocol standards that the storage system complies with.

Table 7-1 Protocol standards

Name	Standard No.
SCSI system	FC-PH: ANSI X3.230
	FC-PH2: ANSI X3.297
	SCSI-FCP: ANSI X.269
	FC-AL: ANSI X.272
	FC-AL-2: ANSI NCITS 332-1999
	FC-SW: ANSI NCITS 321
	FC-SW-2: ANSI NCITS 355-2001
	FC-GS: ANSI X.288 (for FC switch)
	FC-GS2: ANSI NCITS 288 (for FC switch)
	SAS Serial Attached SCSI-1.1 (SAS-1.1)
	SAS Serial Attached SCSI-2.0 (SAS-2.0)
	SAS Serial Attached SCSI-3.0 (SAS-3.0)
	T10/1562D Rev.05 Serial Attached SCSI (SAS)
	T10/1601D Rev.07 Serial Attached SCSI Model-1.1 (SAS-1.1)
	T10/1601D Rev.07 Serial Attached SCSI Model-1.1 (SAS-2.0)
T10/1601D Rev.07 Serial Attached SCSI Model-1.1	

Name	Standard No.
	(SAS-3.0)
	SFF 8301 form factor of 3.5' disk drive
	SFF 8323 3.5' disk drive form factor with serial connector
	SFF 8482 SAS plug connector
	SCSI 3 SAM-2: ANSI INCITS 366-2003
	SPC-2: ANSI INCITS 351-2001
	SBC: ANSI INCITS 306-1998
	PICMG3.0 Advanced Telecommunications Computing Architecture
	PICMG3.1 Ethernet/fiber Channel Over PICMG3.0
	iSCSI RFC 3720/7143
TCP/IP system	SNMP v1
	SNMP v2c
	SNMP v3
PCIe system	PCI Express Base Specification R1.1
	PCI Express to PCI or PCI-X Bridge Specification v1.0
	PCI Express Base Specification v2.0

Interface Standards

Table 7-2 describes the interface standards that the storage systems comply with.

Table 7-2 Interface standards that the storage systems comply with

Name	Description
VAAI	An application programming interface (API) framework from VMware. It enables some storage-related tasks (such as thin provisioning) to be offloaded from a VMware server to a storage array.
SRA	An interface between VMware Site Recovery Manager (SRM) and a storage system. It enables SRM to perform the following operations: discovery of storage systems, non-disruptive failover test, emergency or planned failover, reverse replication, backup, and restoration.
SMI-S	A storage standard developed and maintained by the Storage Networking Industry Association (SNIA). It aims to simplify the management of a storage area network (SAN) that contains devices from various manufacturers. It

Name	Description
	provides a universal management interface for all types of network elements and simplifies the management of a heterogeneous SAN environment.
ODX	Offloaded data transfer (ODX) is a feature of Windows 2012 server. The feature unloads files into storage arrays for transmission. High transmission bandwidth between storage arrays to largely shorten the data transmission delay and improve the data copy speed, while reduce the host server resource utilization rate.

Safety Specifications and EMC Standards

Table 7-3 lists the safety specifications and EMC standards that the storage system complies with.

Table 7-3 Safety specifications and EMC standards

Name	Standard No.
China safety standard	GB 4943
North America safety standard	UL 60950-1
European safety directive	LVD 2006/95/EC
European safety standard	EN 60950-1
China EMC standard	GB9254-2008 (idt CISPR 22: 2006)
	GB17625.1-2003 (idt IEC 61000-3-2: 2001)
Canada EMC standard	ICES-003: 2004
	CAN/CSA-CEI/IEC CISPR 22:02
North America EMC standard	FCC, CFR 47 Part 15, Subpart B
European EMC directive	EMC Directive 2004/108/EC
European EMC standard	EN 55022
	EN 55024

Industry Standards

Table 7-4 lists the industry standards that the storage system complies with.

Table 7-4 Industry standards

Name	Standard No.
Ethernet	IEEE 802.3
Fast Ethernet	IEEE 802.3u
Gigabit Ethernet	IEEE 802.3z
	IEEE 802.3ab
10-Gigabit Ethernet	IEEE 802.3ae
VLAN	IEEE 802.1q
IEEE standard test access port and boundary-scan architecture	IEEE 1149.1-2001
Procedure for failure modes and effects analysis (FMEA)	IEC 812
Presentation of reliability, maintainability and availability predictions	IEC 863
ETSI standard (environment)	ETS 300 019
ETSI standard (power)	ETS 300 132
ETSI standard (noise)	ETS 300 753
ETSI standard (environment)	ETS 300 119
ETSI standard (grounding)	ETS 300 253
ITUT standard (grounding)	ITUT K.27
Environmental protection	ECMA TR/70
Reliability	GR-929, Telcordia SR-332
Clean room and related controlled environments	ISO 14664-1 Class8
Airborne contaminants and environment standards	ANSI/ISA-71.04-1985 severity level G1

8 Certifications

The chapter describes the certifications that the storage system passes.

Table 8-1 lists the certifications that the storage system passes.

Table 8-1 Certifications

Name	Description
CB	<p>The IEC System for Conformity Testing and Certification of Electrical Equipment (IECEE) is based on the use of specific IEC standards for electrical equipment. The Certification Bodies (CB) Scheme is applicable to electrical equipment within the scope of IEC standards for safety, accepted for use in the IECEE. The Scheme becomes operative for such standards as soon as at least one National Certification Body has declared their recognition of CB Test Certificates. The CB scheme is designed for eliminating the international commerce barriers resulted from the compliance with certifications and approval guidelines of different countries.</p> <p>The IEC System for Conformity Testing to Standards for Safety of Electrical Equipment (referred to as the IECEE) is based on the use of specific IEC standards for electrical equipment. The CB Scheme is applicable to electrical equipment within the scope of IEC standards for safety, accepted for use in the IECEE. The Scheme becomes operative for such standards as soon as at least one National Certification Body has declared their recognition of CB Test Certificates.</p>
CCC	<p>China Compulsory Certification (CCC) is a three-in-one authoritative certification incorporating the Conformity Certification of Electrical Equipment (CCEE), the certificate for the safe license of import granted by China Commodity Inspection Bureau (CCIB), and Safety and Electro Magnetic Compatibility (EMC).</p> <p>The China Compulsory Certificate (CCC) mainly involves the products related to human health and security, animal and plant life and health, environmental protection, and public security.</p>
FCC	<p>Federal Communications Commission (FCC) authorizes and manages all RF transmission facilities and devices except for those used by the federal government. It is also responsible for the environmental damages generated by the facilities and devices it approves.</p>
IC	<p>Industry Canada (IC) sets up the test standards for analog and digital terminal</p>

Name	Description
	devices and specifies corresponding EMC certificates that all import electronic products must obtain.
UL	<p>Underwriters Laboratories Inc. (UL): The UL is a non-profit agency engaged in product safety testing.</p> <p>UL has its own certification system for the entire system, components, and materials. All electric products that are exported to the USA must pass the UL certification.</p> <p>The UL safety certification is classified into the following three methods:</p> <p>¹Labeling</p> <p>The UL labeling service is the best known service of the UL safety certification. The UL label on the product indicates that UL has tested the sample of the product according to the safety standards approved by the USA. The sample does not cause fire, creepage, or other dangers if predictable.</p> <p>¹Classification</p> <p>UL tests the product according to different features, in the specified danger range, or under specific cases. In general, the classified products are mostly construction materials or industrial instruments. The classified products include industrial or commercial products. Some specified features must be tested, such as inflammability, hazardous performance, or specifications specified by the government.</p> <p>¹Approval</p> <p>UL tests parts of the product or unfinished product. These parts will be used in the UL labeled product list. This service covers millions of plastics, wires, circuit boards, various finished products, and even some large components, such as motorcycles or power supplies.</p>
CE	<p>Conformite Europeenne (CE): Products marked with CE conform to EMC (2004/108/EC) and low-voltage (2006/95/EC) specifications published by EU.</p> <p>If this product has telecommunication functionality, the R_TTE Directive (1999/5/EC) that complies with the directives mentioned previously implies conformity to the following European norms (in parentheses are the equivalent international standards and regulations):</p> <p>¹EN 55022 (CISPR 22)-Electro Magnetic Interference</p> <p>¹EN 55024 (IEC61000-4-2, 3, 4, 5, 6, 8, 11)-Electro Magnetic Immunity</p> <p>¹EN 60950 (IEC 60950)-Product Safety</p>
REACH	<p>REACH is a set of comprehensive regulations that require all chemical products that are both imported and produced in Europe must be registered, assessed, authorized, and restricted. In this way, customers can easily recognize the chemical elements. Thus, both humans and environment are protected.</p>
RoHS	<p>The restriction of the use of certain hazardous substances in electrical and electronic equipment (RoHS) is the directive that restricts the use of certain hazardous substances in the electrical, electronic equipment.</p> <p>RoHS is an European Union (EU) compulsory standard that is designed to regulate the materials and the technical standard of the electrical and</p>

Name	Description
	electronic products. In this way, it does good to human health and environment protection. That is, the six hazardous substances of lead (Pb), mercury (Hg), cadmium (Cd), hexavalent chromium (Cr6+), polybrominated biphenyl (PBB), polybrominated diphenyl ethers (PBDE) can not exceed the specified limits.
WEEE	The EU Directive on Waste of Electric and Electronic Equipment. Electrical and electronic products sold in the EU market must comply with this directive and have the mark of cross out wheeled bin.
GOST	The national standard certification of Russia. Based on Russian Consumer Protection Law, certain consumable products that are sold to Russia must meet the security, Electro Magnetic Interference (EMI), and sanitation requirements. Based on the product certification and service laws, the products should be awarded the GOST certification.
C-TICK	A mandatory certification issued by Australian Communications Authority (ACA) for communication equipment, mainly concerning EMC requirements.
SONCAP	A certification issued by Standards Organization of Nigeria. The products in the certification item list must acquire SONCAP for the entrance to Nigeria market.

9 Operation and Maintenance

The storage systems can be operated and maintained by using the ActiveManager and the command-line interface (CLI), adapting to different environments and user habits.

Introduction to the ActiveManager

Figure 9-1 shows the ActiveManager main window.

Figure 9-1 ActiveManager main window

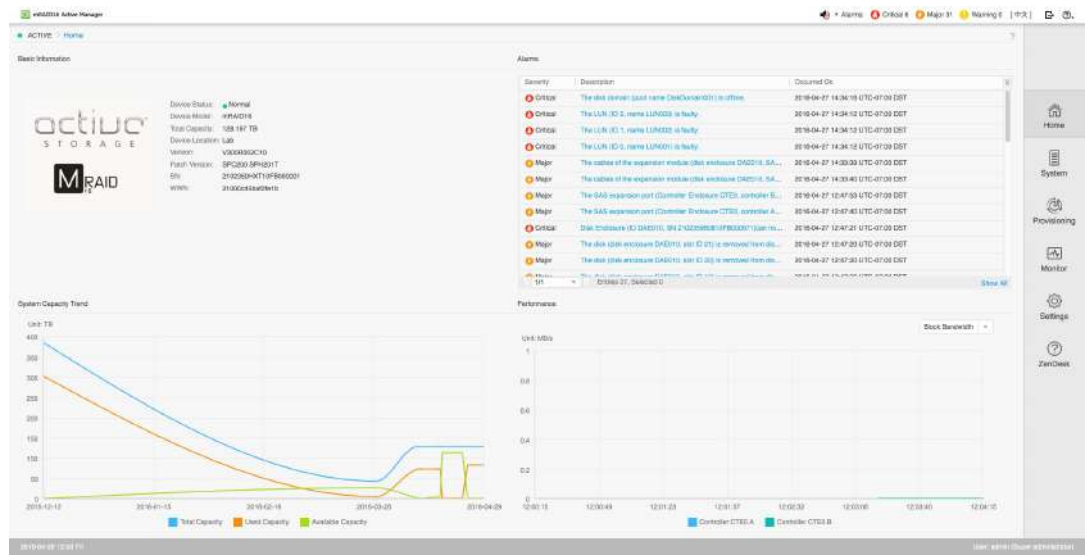

Table 9-1 describes the components of the ActiveManager main window.

Table 9-1 Components of the ActiveManager main window

No.	Name	Description
1	Function pane	The function pane shows a page associated with the current operation.
2	Status bar	The status bar shows information such as the user name currently logged in and the login time.

No.	Name	Description
3	Navigation bar	The navigation bar shows the function modules of a storage system. Users can click a function module to configure the corresponding functions.
4	Exit, help, and language selection area	This area displays an exit button, a help button, and a language selection button.
5	Fault statistics area	The fault statistics area shows the number of each level of system faults, helping users learn about the running status of a storage system.

Users can log in to the ActiveManager by using a common browser.

Introduction to the CLI

The CLI enables users to manage and maintain the V3 series storage systems using command lines.

Users need to log in to the CLI by using terminal software, such as the HyperTerminal provided by Windows, or PuTTY.

There are two ways to log in to the CLI.

- 1 Log in through a serial port of a storage system. To connect to a serial port, the maintenance terminal must be located next to the storage system. Therefore, this login mode is applicable to the scenario where a user does not know the management IP address of a storage system or a storage system is faulty.
- 1 Log in through a management network port of a storage system. When there are reachable routes, a user can log in to the CLI by entering the IP address of the management network port of a storage system in the terminal software. IP networks are easily accessible. Therefore, a user can log in to a storage system remotely, and this login mode is more popular.

A How to Obtain Help

If a tough or critical problem persists in routine maintenance or troubleshooting, contact Active Storage for technical support.

A.1 Preparations For Contacting Active Storage

To better solve the problem, you need to collect troubleshooting information and make debugging preparations before contacting Active Storage.

A.2 How to Use the Document

Active Storage provides guide documents shipped with the device. The guide documents can be used to handle the common problems occurring in daily maintenance or troubleshooting.

A.3 How to Obtain Help from Website

Active Storage provides users with timely and efficient technical support through the regional offices, secondary technical support system, telephone technical support, remote technical support, and onsite technical support.

A.4 Ways to Contact Active Storage

Active Storage provides customers with comprehensive technical support and service. For any assistance, contact our local office or company headquarters.

A.1 Preparations For Contacting Active Storage

To better solve the problem, you need to collect troubleshooting information and make debugging preparations before contacting Active Storage.

A.1.1 Collecting Troubleshooting Information

You need to collect troubleshooting information before troubleshoot.

You need to collect the following information:

- 1 Name and address of the customer
- 1 Contact person and telephone number
- 1 Time when the fault occurred
- 1 Description of the fault phenomena
- 1 Device type and software version
- 1 Measures taken after the fault occurs and the related results

1 Troubleshooting level and required solution deadline

A.1.2 Making Debugging Preparations

When you contact Active Storage for help, the technical support engineer of Active Storage might assist you to do certain operations to collect information about the fault or rectify the fault directly.

Before contacting Active Storage for help, you need to prepare the boards, port modules, screwdrivers, screws, cables for serial ports, network cables, and other required materials.

A.2 How to Use the Document

Active Storage provides guide documents shipped with the device. The guide documents can be used to handle the common problems occurring in daily maintenance or troubleshooting.

To better solve the problems, use the documents before you contact Active Storage for technical support.

A.3 How to Obtain Help from Website

Active Storage provides users with timely and efficient technical support through the regional offices, secondary technical support system, telephone technical support, remote technical support, and onsite technical support.

Contents of the Active Storage technical support system are as follows:

- 1 Active Storage headquarters technical support department
- 1 Regional office technical support center
- 1 Customer service center
- 1 Technical support website: <http://support.active-storage.com/hc/en-us>

A.4 Ways to Contact Active Storage

Active Storage, LLC provides customers with comprehensive technical support and service. For any assistance, contact our local office or company headquarters.

Active Storage, LLC.

Address: 9233 Eton Ave. Chatsworth, CA 91311 USA

Website: <http://active-storage.com>

B Glossary

A

AC power module	The module that transfers the external AC power supply into the power supply for internal use.
Application server	A service-processing node (a computer device) in the network. Application programs of data services are run on the application server.
Asynchronous remote replication	A kind of remote replication. When the data on the primary site is updated, the data does not need to be updated on the mirroring site synchronously to finish the update. In this way, performance is not reduced due to data mirroring.

B

Backup	A periodic operation performed on the data stored in the database for the purposes of database recovery in case that the database is faulty. The backup also refers to data synchronization between active and standby boards.
Bandwidth	A range of transmission frequencies a transmission line or channel can carry in a network. In fact, the bandwidth is the difference between the highest and lowest frequencies in the transmission line or channel. The greater the bandwidth, the faster the data transferrate.
Baud rate	The number of times per second the signal can change on a transmission line. Commonly, the transmission line uses only two signal states, making the baud rate equal to the number of bits per second that can be transferred. The underlying transmission technique may use some of the bandwidth, so it may not be the case that user data transfers at the line's specified bit rate.
Bit error	An incompatibility between a bit in a transmitted digital signal and the corresponding bit in the received digital signal.
Bit error rate	Ratio of received bits that contain errors. BER is an important index used to measure the communications quality of a network.
Bonding	Bonding can bind multiple independent physical network ports into a logical port, which ensures the high availability of server network

	connections and improving network performance.
Boundary scan	A test methodology that uses shift registers in the output connections of integrated circuits. One IC often is connected to the next. A data pattern is passed through the chain and the observed returned data stream affected by the circuit conditions gives an indication of any faults present. The system is defined under IEEE standard 1149.1 and is also often known as JTAG (Joint Test Action Group).
Browser/Server	An architecture that defines the roles of browser and server, where the browser is the service request party and the server is the service provider.
Backup window	An interval of time during which a set of data can be backed up without seriously affecting applications that use the data.
C	
Cache hit ratio	The ratio of directly accessed I/O from Cache to all the I/O operation during the read operation.
Cache prefetch strategy	According to the operation in which data has been read or is being read, the required data is read from a disk into the cache in advance.
Captive Screw	After the screw is loosened, screw caps and bolts are not disconnected from the main body.
Cascading	Connect the storage system to more disk enclosures through connection cables, thus expanding the capacity of the storage system.
CHAP	A method to periodically verify the identity of the peer using a 3-way handshake. During the establishment of a link, the authenticator sends a "challenge" message to the peer. The peer responds with a value calculated using a "one-way hash" function. The authenticator checks the response against its own calculation of the expected hash value. If the values match, the authentication is acknowledged. CHAP provides protection against playback attack.
Clone	A snapshot technology. The source data is completely copied to generate a data duplicate; therefore the duplicate needs the storage space as the same size as the source data. It is also called clone. In the VIS system, it is also called third-mirror break-off snapshot.
Cluster	A mechanism adopted to improve the system performance. Several devices of the same type form a cluster. The exterior of a cluster is some like a kind of equipment. In the interior of a cluster, the nodes share the load.
Coffer	A technology for ensuring data security and integrity in a storage system. It is used to store the mission-critical data of the system.
Coffer disk	Disks that build up the coffer.
Command device	A special LUN through which the host can send inband commands to storage devices.
Constant prefetch	A cache prefetch strategy. The size of the data to be prefetched is the size as set. This strategy applies to the applications that require reading data of a fixed size in a certain order. An example is the

	streaming media demanded by multiple subscribers who use the same bit rate.
Controller	The core module that processes services in a storage system. It contains physical components such as system-level CPUs and memory.
Controller enclosure	An enclosure that accommodates controllers and provides storage services. It is the core component of a storage system, and generally consists of components such as controllers, power supplies, and fans.
Copyback	The process of copying the data from the hot spare disk back to the previous disk when the faulty member disk is restored or replaced by a new one.
Copying	A state of pair. The state indicates that the source LUN data is being synchronized to the target LUN.
Continued Mirror	After storage controller became fault, a method of data in the LUN to write mirror into other storage controller, while ensure data integrity and uninterrupted operation host services.
D	
Data compression	Encoding data to take up less storage space and less bandwidth for transmission.
Data deduplication	A specialized data compression technique for eliminating coarse-grained redundant data, typically to improve storage utilization. In the deduplication process, duplicate data is deleted, leaving only one copy of the data to be stored, along with references to the unique copy of data. Deduplication is able to reduce the required storage capacity since only the unique data is stored.
Data flow	A process that involves processing the data extracted from the source system, such as filtering, integration, calculation, and summary, finding and solving data inconsistency, and deleting invalid data so that the processed data meets the requirements of the destination system for the input data.
Data migration	It is the process to cleanse and transform history data, and then load them to the new system.
Data source	A system, database, or file that can make BOs persistent. A data source can be a database instance or a database user.
Data switch	A data switch used for interconnections between controllers.
Dirty data	The data that is stored temporarily on cache and has not been written onto disks.
Disaster recovery	A system deployment solution aiming at reducing loss in disasters. A set of disaster recovery system that is the same as the production system is deployed as a backup to store the production data when a fault occurs in the production system. The applications are switched over to the disaster recovery system before the production system recovers. After the production system recovers, the applications are switched back to the production system.

Disk array	A set of disks from one or more commonly accessible disk subsystem. These disks are combined and controlled by the control software. The control software provides the storage capacity of these disks for hosts as one or more virtual disks.
Disk Domain	A combination of disks. A disk domain consists of the same type or different types of disks. Disk domains are isolated from each other. Therefore, services carried by different disk domains do not affect each other in terms of performance and faults (if any).
Disk location	The process of locating a hard disk, that is, determining the enclosure ID and slot ID of the hard disk in the storage system.
Disk enclosure	It consists of the following parts in redundancy: expansion module, hard disk, power module, and fan module. System capacity can be expanded by cascading multiple disk enclosures.
Disk utilization	The percentage of used capacity in the total available capacity.

E

eDevLUN (external device LUN)	Logic space created by third-party storage systems.
Engine	Two controllers in one enclosure are called Engine.
Expansion	Connecting a storage system to more disk enclosures through connection cables, thus expanding the capacity of the storage system.
Expander module	A component used for expanding.

F

Failover	The automatic substitution of a functionally equivalent system component for a failed one. The term failover is most often applied to intelligent controllers connected to the same storage devices and host computers. If one of the controllers fails, failover occurs, and the survivor takes over its I/O load.
Field replaceable unit	A unit that can function as a circuit board, part, or component of an electronic device. It can be quickly and easily removed from a personal computer or other electronic devices. If an FRU becomes faulty, users can replace it with a new one instead of sending the entire product or system for maintenance.
File Engine	The component in a unified storage systems that provides file-level service.
Firmware	The programmable software part in a hardware component. A firmware is a part of hardware, but is scalable as software.
Front-end host port	The port that connects the controller enclosure to the service side and transfers service data. There are three types of front-end host ports: SAS, FC, and iSCSI.

G

Gateway	A device that connects two network segments using different protocols. It is used to translate the data in the two network segments.
Global system for mobile communications	The second-generation mobile networking standard defined by European Telecommunications Standards Institute (ETSI). It is aimed at designing a standard for global mobile phone networks. The standard allows a subscriber to use a phone globally. GSM consists of three main parts: mobile switching subsystem (MSS), base station subsystem (BSS), and mobile station (MS).

H

Hard disk	A non-volatile storage device that stores digitally encoded data on rapidly rotating platters with magnetic surfaces. Hard disks generally offer more storage and quicker access to data than floppy disks do.
Hard disk tray	The tray that bears the hard disk.
Hard quota	The value to limit the space used in quota configuration. If the space used arrives hard quota, file operation is not allowed to continue.
Heartbeat	Heartbeats are the packets, requiring no acknowledgement, transmitted between two devices. The device can judge the validity status of the peer device. Heartbeat supports node communication, fault diagnosis, and event triggering.
Hit ratio	The ratio of directly accessed I/Os from cache to all I/Os.
Hot swap	A technology used to replace system components without shutting down the system, which improves the reliability and maintainability of a system.
HyperVault	A self-protective property of the data built in storage device.
HyperMetro	A value-added service of storage systems. HyperMetro means that two datasets on two storage systems can provide storage services as one dataset to achieve load balancing among applications and failover without service interruption.
HyperMetro Domain	A HyperMetro configuration object. Several storage arrays and Quorum Servers constitute a HyperMetro Domain. HyperMetro services can be created on a HyperMetro Domain.

I

I/O	Data movement process between memory and peripheral devices in the computer system. I/O is a collective name, indicating the operations reading data into the memory and writing data to other places from computer memory.
Inband management	Inband management means that the management control information of the network and the carrier service information of the user network are transferred through the same logical channel. Inband management enables users to manage storage arrays through commands. Management commands are sent through service channels, that is, I/O

	write and read channels. The advantages of inband management include high speed, stable transfer, and no additional management network ports required.
Initiator	A system component that can initiate an I/O operation on an I/O bus or on a network.
Intelligent prefetch	A cache prefetch strategy. The system software calculates a proper size of prefetched data. This strategy applies to a read application involving a single bit stream or to the situations where you do not know whether the data is read in a certain order. An example is reading or writing a file.
Interface module	A field replaceable module that accommodates the service or management ports.
L	
Load balance	A method of adjusting the system, application components and data to averagely distribute the applied I/O or computing requests for physical resources of the system.
Load the file system in mini mode	A method of restoring the user data in an offline file system.
Logical unit	The entity is located inside the SCSI object, and can execute I/O commands. After a SCSI I/O command is sent to an object, the logic unit inside the object executes this command. Usually, each SCSI physical disk has one logic unit. A tape drive and array controller may have multiple logic units, which process different I/O commands. Each logic unit inside an array controller corresponds to a virtual disk.
Logical unit number	The number of a logical disk that the host can access.
LUN formatting	The process of writing 0 bits in the data area on the logical drive and generating related parity bits so that the logical drive can be in the ready state.
LUN mapping	The storage system maps LUNs to ASs so that the ASs can access the storage reorganization.
LUN migration	A method for the data in the LUN to migrate between different physical storage space while ensuring data integrity and uninterrupted operation host services.
LUN copy	The function of copying the original LUN data to one or multiple target LUNs.
M	
Maintenance terminal	The computer that is connected through a serial port or management network port and maintains the storage system.
Management	An entity that provides a means to transmit and process the

network	information related to network management.
Management network port	The network port on the controller enclosure that is connected to the maintenance terminal. It is provided for the remote maintenance terminal.
N	
Node	A managed device in the network. For a device with a single frame, one node stands for one device. For a device with multiple frames, one node stands for one frame of the device.
O	
Out-of-band management	A management mode used during out-of-band networking. In the out-of-band management mode, the management and control information of the network and the bearer service information of the user network are transmitted through different logical channels.
Owning controller	The controller that can prior access a certain LUN.
P	
Power failure protection	When the external power failure occurs, the AC PEM depends on the battery for power supply, which ensures the integrity of the dirty data in cache.
Pre-copy	When the system monitors that a member disk in a RAID group is to fail, the system copies the data on the disk to a hot spare disk in advance. This technology is called pre-copy.
Primary backup	A kind of backup mode for file system, means that create a copy (snapshot) for filesystem.
Primary restore	A kind of restore mode for file system, means that restore a copy (snapshot) to filesystem.
Primary storage controller	The controller that plays a leading role in controlling the management is the primary storage controller. It can perform relevant management operations on the controller enclosure.
Primary/Secondary switchover	A process for the conversion of the primary/secondary relationship.
Prior controller	For the application server LUN, prior controller means that the working controller is the owner controller of the corresponding array LUN.
Q	
Quota tree	A first-level directory of file system that can be managed with quota.
Quorum Server	A server that can provide arbitration services. The server can provide

	arbitration services for clusters or HyperMetro to prevent conflicts of resource access by multiple application servers.
Quorum Server Mode	A HyperMetro arbitration mode. When a HyperMetro arbitration occurs, the Quorum Server decides which site wins the arbitration.
R	
RAID level	The application of different redundant types to a logical drive. A RAID level improves the fault tolerance or performance of the logical drive but reduces the available capacity of the logical drive. You must specify a RAID level for each logical drive.
Reconstruction	The process of restoring the data saved on a faulty member disk in a RAID group.
Redundancy	The scheme to add more than one channels, elements or parts that have the same functions with the counterparts in the system or device at a critical place. When a fault occurs, the system or device can work well, and the reliability is then improved.
Remote replication	A core technology for disaster recovery and a foundation that implements remote data synchronization and disaster recovery. This technology remotely maintains a set of data mirror through the remote data connection function of the storage devices that are separated in different places. Even when a disaster occurs, the data backup on the remote storage device is not affected. Remote replication can be divided into synchronous remote replication and asynchronous remote replication by whether the host that requires mirrors needs the confirmation information of the remote replication site.
Reverse synchronizing	The process of restoring data from the redundancy machine (RM) when the services of the production machine (PM) are recovering.
Route	The path that network traffic takes from its source to its destination. In a TCP/IP network, each IP packet is routed independently. Routes can change dynamically.
S	
Script	A collection of data statements used to perform an operation.
Secondary backup	A kind of backup mode for file system, means that backup the data of the primary file system to the remote file system on the secondary array.
Secondary restore	A kind of restore mode for file system, means that restore the data of the secondary file system to the primary file system on the secondary array.
Secondary controller	(1) A controller that backs up service and management data of the primary controller in a clustered system. When the primary controller fails, the secondary controller is upgraded to the primary controller and takes over the management and services of the controller enclosure. (2) A controller that backs up the management data of the

	<p>primary controller in a block-level array. When the primary controller fails, the secondary controller is upgraded to the primary controller and takes over the management of the system.</p>
Serial port	<p>An input/output location (channel) that sends and receives data to and from a computer's CPU or a communications device one bit at a time. Serial ports are used for serial data communication and as interfaces with some peripheral devices, such as mice and printers.</p>
Service data	<p>The user and/or network information required for the normal functioning of services.</p>
Service network port	<p>The network port that is used to store services.</p>
SFP optical transceiver	<p>A component that can make data conversion between optical signals and electrical signals and that can receive and transfer data.</p>
Simple network management protocol	<p>A network management protocol of TCP/IP. It enables remote users to view and modify the management information of a network element. This protocol ensures the transmission of management information between any two points. The polling mechanism is adopted to provide basic function sets. According to SNMP, agents, which can be hardware as well as software, can monitor the activities of various devices on the network and report these activities to the network console workstation. Control information about each device is maintained by a management information block.</p>
Single point of failure	<p>A type of failure. Data transmission over a network is stopped and cannot be recovered automatically if a single point failure occurs. The point can be an interface, a board, a device, or a link.</p>
Small computer system interface	<p>A set of standards for physically connecting and transferring data between computers and peripheral devices. SCSI is most commonly used for hard disks and tape drives, but it can connect a wide range of other devices, including scanners, and optical drive.</p>
Smart tenancy	<p>A feature of Active Storage storage system. With Smart Tenancy, multiple virtual storage systems can be created in one physical storage system, which allows tenants to share the same storage system hardware resource without affecting data security and privacy of each other. This feature achieves more flexible, easy-to-manage and low-cost shared storage in a multi-protocol unified storage architecture.</p>
Snapshot	<p>A data backup technology through which a fully usable copy of a data object can be quickly generated. The duplicate contains the image of the data object at a point in time.</p>
Snapshot copy	<p>A copy of the snapshot LUN, which is also a snapshot LUN.</p>
Soft quota	<p>The value to alarm space usage in quota configuration. After used space arrives this value, an alarm triggered; if space used from above this value becomes lower than, the previous alarm eliminated.</p>
Source LUN	<p>The LUN where the original data is located.</p>
Static Priority Mode	<p>A HyperMetro arbitration mode. When a HyperMetro arbitration occurs, the preferred site always wins the arbitration.</p>

Storage Pool Shrinking	A method of shrinking the total capacity of Storage Pool.
Storage system	An integrated system. It consists of the following parts: controller, storage array, host bus adapter, physical connection between storage units, and all control software.
Storage unit	An abstract definition of backup storage media for storing backup data. The storage unit is connected with actual storage media, used to back up data.
Streaming media	The media by which content is transmitted continuously with the streaming method in real time. Streaming media ensure high-quality playback effects at low bandwidth by integrating with the following technologies: data collection, data compression, encoding, storage, transmission, terminal playback, and network communication.
Stripe	The set of strips at corresponding locations of each member extent of a disk array which uses striped data mapping. The strips in a stripe are associated with each other in a way (e.g., relative extent block addresses) that allows membership in the stripe to be quickly and uniquely determined by a computational algorithm. Parity RAID uses stripes to map virtual disk block addresses to member extent block addresses.
Subnet	A type of smaller networks that form a larger network according to a rule, for example, according to different districts. This facilitates the management of the large network.
Subnet mask	The technique used by the IP protocol to determine which network segment packets are destined for. The subnet mask is a binary pattern that is stored in the device and is matched with the IP address.
Synchronous remote replication	A kind of remote replication. When the data on the primary site is updated, the data must be synchronously updated on the mirroring site before the update is complete. In this way, the data that is stored on both the primary and mirroring sites can be synchronized.
T	
Target	A system component that can receive SCSI I/O operation commands.
Target LUN	The LUN on which target data resides.
Tenant	A property of SmartTenancy, which represents a virtual storage system in a physical one. The private and independent logical resource of a tenant mainly includes disk domain space, LUN, file system and ports. Tenants get complete storage services, but also remain resource and network isolation with other tenants, which avoids interference.
Thin provisioning	A mechanism that offers on-demand allocation of storage space.
Thin LUN	The thin LUN is a logic disk that can be accessed by hosts. The thin LUN dynamically allocates storage resources from the thin pool according to the actual capacity requirements of users.
Timing Snapshot	To create snapshots periodically to continuously protect data.

Topology	The configuration or layout of a network formed by the connections between devices on a local area network (LAN) or between two or more LANs.
Trap	A type of SNMP message that indicates the occurrence of an event. This type of message is transmitted to the receiver through UDP. The transmission process is not completely reliable.
U	
User datagram protocol	A TCP/IP standard protocol that allows an application program on one device to send a datagram to an application program on another. User Datagram Protocol (UDP) uses IP to deliver datagram. UDP provides application programs with the unreliable connectionless packet delivery service. There is a possibility that UDP messages will be lost, duplicated, delayed, or delivered out of order. The destination device does not confirm whether a data packet is received.
User interface	The space in which users interact with a machine.
V	
Variable prefetch	A cache prefetch strategy. The size of the data to be prefetched is the multiple for prefetching multiplied by the length of a read command. This strategy applies to the applications that require reading data of variable size in a certain order or to the situations where multiple subscribers read data concurrently but no fixed prefetch size can be set, because the amount of pre-read data cannot be judged. An example is the streaming media demanded by multiple subscribers who use different bit rates.
vStore	A property of SmartTenancy. In Active Storage SmartTenancy, a tenant is called a vStore, which represents a virtual storage system.
W	
Working controller	The controller that reads data from and writes data onto LUNs or file systems in a storage array.
Write back	A caching technology in which the completion of a write request is signaled as soon as the data is in cache, and actual writing to non-volatile media occurs at a later time. Write back includes an inherent risk that an application will take some action predicated on the write completion signal, and a system failure before the data is written to non-volatile media will cause media contents to be inconsistent with that subsequent action. For this reason, good write back implementations include mechanisms to preserve cache contents across system failures (including power failures) and to flush the cache at system restart time.
Write through	A caching technology in which the completion of a write request is not signaled until data is safely stored on non-volatile media. Write performance with the write through technology is approximately that

of a non-cached system, but if the data written is also held in cache, subsequent read performance may be dramatically improved.

Z**Zone**

A Fibre Channel switch function that is similar to the VLAN function for Ethernet switches. It logically allocates the devices including hosts and storage systems on a SAN to different zones. In this way, the devices in different zones cannot directly access each other over a Fibre Channel network, implementing device isolation on the SAN.

C Acronyms and Abbreviations

A

ANSI American National Standards Institute

B

BBU Backup Battery Unit

C

CLI Command Line Interface

F

FC Fiber Channel

FC-AL Fiber Channel Arbitrated Loop

G

GUI Graphical User Interface

I

IP Internet Protocol

ISA Instrument Society of America

iSCSI Internet Small Computer Systems Interface

ISM Integrated Storage Manager

ISO International Organization for Standardization

L

LUN	Logical Unit Number
M	
MTBF	Mean Time Between Failure
MTTR	Mean Time to Failure
R	
RAID	Redundant Array of Independent Disks
RSCN	Registered State Change Notification
S	
SAN	Storage Area Network
SAS	Serial Attached SCSI
SCSI	Small Computer System Interface
SSD	Solid State Drive
V	
VLAN	Virtual LAN
VPN	Virtual Private Network